

2018

SUPEROFFERTA



€ Senza IVA
59/2018



Series

EDIZIONE 1 - Valida fino al 31/08/2018

LE NOVITÀ PIÙ IMPORTANTI

GAMMA CARRELLI E BANCHI



NEW

PAGINA

4

GAMMA PINZE



NEW

PAGINA

20

MINI KIT SERRAGGIO



NEW

PAGINA

40

Moduli in spugna



NEW

PAGINA 14

Moduli in plastica



NEW

PAGINA 16

Utensili isolati



PAGINA 26

Giraviti ed inserti



PAGINA 27

Chiavi maschio



NEW

PAGINA 30

Chiavi di manovra



NEW

PAGINA 34

Speciale pollici



NEW

PAGINA 38

Set di bussole



NEW

PAGINA 42

Valigie per manutenzione



NEW

PAGINA 48

Altri contenitori



PAGINA 50

Elettrotecnica



PAGINA 52

Taglio e manutenzione



NEW

PAGINA 54

Estrattori



PAGINA 57

Idraulica



NEW

PAGINA 58

Serraggio controllato



PAGINA 60

Illuminazione



NEW

PAGINA 62

Pneumatica



PAGINA 66

Abbigliamento



NEW

PAGINA 68

Autoriparazione



NEW

PAGINA 70

Matrix



NEW

PAGINA 82

900 KG



Racing 519



TOP DI GAMMA
MANIGLIE BASCULANTI IN ALLUMINIO



1. Maniglie dei cassetti in Alluminio anodizzato con sistema di aggancio basculante
2. Profili paraurti in gomma sui montanti e sui cassetti
3. Piano di lavoro in acciaio inox

900 KG



SPRINT 518



SEMPLICE E ROBUSTO
MANIGLIE FISSE IN ALLUMINIO

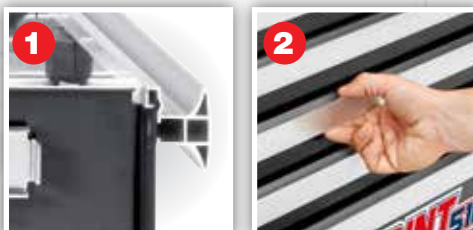

1. Maniglie dei cassetti fisse in Alluminio anodizzato. Design a doppia T per la presa dall'alto o dal basso
2. Guide con sistema di richiamo a fine corsa e tenuta del cassetto rinforzata

800 KG















START 516



QUALITÀ E CONVENIENZA
MANIGLIE BASCULANTI IN ABS



1. Piano di lavoro in ABS ad alta resistenza con bordi anticaduta
2. Maniglie per apertura cassetti in ABS con sistema di aggancio basculante

	CARRELLI				CASSETTIERE	BANCHI a cassetiera 6 cassetti
	5 cassette	6 cassette	7 cassette	8 cassette	4 cassette	
519 RACING						
518 SPRINT						
516 START						

START⁵¹⁶
GAMMA CARRELLI

800 KG



NEW

516 SP7V

Cod. U05160007

7

CASSETTI

3

MODULI

Carrello START - 7 cassetti (vuoto)

- Dimensioni interne:
 - 5 cassetti 570x420x60 mm
 - 1 cassetto 570x420x130 mm
 - 1 cassetto 570x420x200 mm

~~€ 660,00~~

€ 420,00

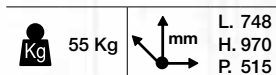

800 KG



516 SP6V

Cod. U05160006

6

CASSETTI

3

MODULI

Carrello Start - 6 cassetti (vuoto)

- Dimensioni interne:
 - 3 cassetti 570x420x60 mm
 - 2 cassetti 570x420x130 mm
 - 1 cassetto 570x420x200 mm

~~€ 580,00~~

€ 380,00

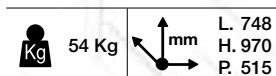

800 KG



NEW

516 SP5V

Cod. U05160005

5

CASSETTI

3

MODULI

Carrello Start - 5 cassetti (vuoto)

- Dimensioni interne:
 - 2 cassetti 570x420x60 mm
 - 2 cassetti 570x420x130 mm
 - 1 cassetto 570x420x270 mm

~~€ 550,00~~

€ 355,00

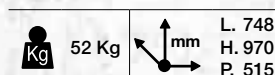



800 KG



516 SP4V

Cod. U05160004

4

CASSETTI

3

MODULI

Cassettiera START - 4 cassette (vuota)

- Sovrapponibile ai carrelli Start 516 SP
- Dimensioni interne:
 - 3 cassette 570x420x60 mm
 - 1 cassette 570x420x130 mm

~~€ 390,00~~

€ 273,00

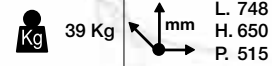

39 Kg

L. 748
H. 650
P. 515



800 KG



516 SP6SV

Cod. U05160013

6

CASSETTI

3

MODULI

Carrello START con sistema antiribaltamento - 6 cassette (vuoto)

- Dimensioni interne:
 - 3 cassette 570x420x60 mm
 - 2 cassette 570x420x130 mm
 - 1 cassetto 570x420x200 mm

~~€ 660,00~~

€ 462,00

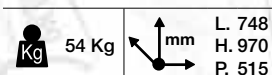

54 Kg

L. 748
H. 970
P. 515

800 KG



516 S6XLV

Cod. U05160010

6

CASSETTI

4

MODULI

Carrello Start XL - 6 cassette (vuoto)

- Dimensioni interne:
 - 3 cassette 760x420x60 mm
 - 2 cassette 760x420x130 mm
 - 1 cassetto 760x420x200 mm

~~€ 713,00~~

€ 499,00

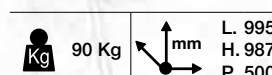

90 Kg

L. 995
H. 987
P. 500

995 mm

START⁵¹⁶

BANCHI DA LAVORO

Struttura rinforzata
in lamiera verniciata

1000 KG

Piano di lavoro in lamiera d'acciaio zincata
(spessore 2,5 mm) con bordi anticaduta

Chiusura di
sicurezza
a serratura
centralizzata

NEW

2000 mm

Fornito con sistema
porta flaconi posizionabile
a destra o a sinistra



NEW

Kg	118	mm	L. 2000
			H. 852
			P. 700

ACCIAIO

NEW

Kg	118	mm	L. 2000
			H. 852
			P. 700

LEGNO

516 SPC2

Cod. U05160021

6

CASSETTI

3

MODULI

**Banco da lavoro START
con piano in acciaio INOX - 6 cassetti**

- Dimensioni interne cassetti:
 - 3 cassetti 570x420x60 mm
 - 2 cassetto 570x420x130 mm
 - 1 cassetto 570x420x200 mm

~~€ 1.100,00~~

€ 720,00

516 SPC1

Cod. U05160020

6

CASSETTI

3

MODULI

**Banco da lavoro START
con piano in legno - 6 cassetti**

- Dimensioni interne cassetti:
 - 3 cassetti 570x420x60 mm
 - 2 cassetto 570x420x130 mm
 - 1 cassetto 570x420x200 mm

~~€ 1.100,00~~

€ 720,00

Racing 519

BANCHI DA LAVORO

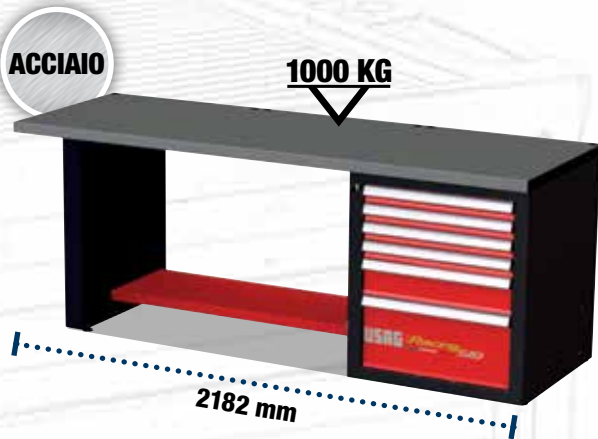

519 RC2 H1

Cod. U05192004

6
CASSETTI

3
MODULI

**Banco da lavoro RACING
con piano in acciaio INOX**

- Dimensioni interne cassetti:
- 4 cassetti 570x420x60 mm
- 1 cassetto 570x420x130 mm
- 1 cassetto 570x420x270 mm

~~€ 1.865,00~~

€ 1.303,00



516 RC1 H1

Cod. U05192003

6
CASSETTI

3
MODULI

**Banco da lavoro RACING
con piano in legno**

- Dimensioni interne cassetti:
- 4 cassetti 570x420x60 mm
- 1 cassetto 570x420x130 mm
- 1 cassetto 570x420x270 mm

~~€ 1.862,00~~

€ 1.303,00

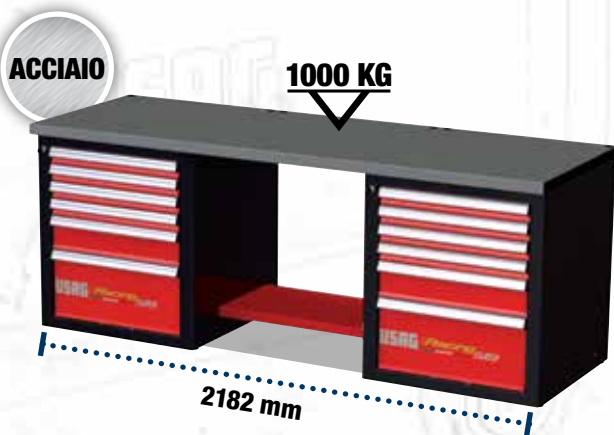

519 RD2 H1

Cod. U05192002

12
CASSETTI

3
MODULI

**Banco da lavoro RACING
con piano in acciaio INOX**

- Dimensioni interne cassetti:
- 8 cassetti 570x420x60 mm
- 2 cassetti 570x420x130 mm
- 2 cassetti 570x420x270 mm

~~€ 2.793,00~~

€ 1.955,00



519 RD1 H1

Cod. U05192001

12
CASSETTI

3
MODULI

**Banco da lavoro RACING
con piano in legno**

- Dimensioni interne cassetti:
- 8 cassetti 570x420x60 mm
- 2 cassetti 570x420x130 mm
- 2 cassetti 570x420x270 mm

~~€ 2.793,00~~

€ 1.955,00



GAMMA CARRELLI



900 KG

72 Kg	L. 774 H. 971 P. 546
-------	----------------------------



900 KG



900 KG

74 Kg	L. 774 H. 971 P. 546
-------	----------------------------



900 KG

76 Kg	L. 774 H. 971 P. 546
-------	----------------------------



519 R6/3V
Cod. U05190414

6 CASSETTI
3 MODULI

Carrello Racing 6 cassetti (vuoto)

- 4 cassetti: H 60 mm
- 1 cassetto: H 130 mm
- 1 cassetto: H 270 mm

~~€ 962,00~~

€ 673,00



519 R6/3NV
Cod. U05190424

6 CASSETTI
3 MODULI

Carrello Racing 6 cassetti (vuoto)

~~€ 962,00~~

€ 673,00



519 R7/3V
Cod. U05190415

7 CASSETTI
3 MODULI

Carrello Racing 7 cassetti (vuoto)

- 5 cassetti: H 60 mm
- 1 cassetto: H 130 mm
- 1 cassetto: H 200 mm

~~€ 1.055,00~~

€ 739,00



519 R8/3V
Cod. U05190416

8 CASSETTI
3 MODULI

Carrello Racing 8 cassetti (vuoto)

- 6 cassetti: H 60 mm
- 2 cassetti: H 130 mm

~~€ 1.147,00~~

€ 803,00



1000 KG

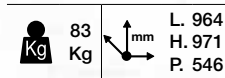

1000 KG

NEW



1100 KG

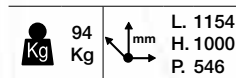

519 R6/4V

Cod. U05190419

6
CASSETTI

4
MODULI

Carrello Racing 6 cassetti (vuoto)

- 4 cassetti: H 60 mm
- 1 cassetto: H 130 mm
- 1 cassetto: H 270 mm

~~€ 1.120,00~~

€ 784,00



519 R6/4NV

Cod. U05190429

6
CASSETTI

4
MODULI

Carrello Racing 6 cassetti (vuoto)

~~€ 1.120,00~~

€ 784,00



519 R6/5V

Cod. U05190420

6
CASSETTI

5
MODULI

Carrello Racing 6 cassetti (vuoto)

- Ruote in gomma antiolio (ø 160 mm)
- 3 cassetti: H 60 mm
- 2 cassetti: H 130 mm
- 1 cassetto: H 200 mm

~~€ 1.444,00~~

€ 1.011,00

CASSETTIERE RACING SOVRAPPONIBILI



519 R4/3V

Cod. U05190410

4
CASSETTI

3
MODULI

Cassettiera 4 cassetti (vuota)

- Per carrelli Racing 519 R a 3 moduli
- 3 cassetti: 570x420x60 mm
- 1 cassetto: 570x420x130 mm

~~€ 737,00~~

€ 516,00



519 R4/4V

Cod. U05190411

4
CASSETTI

4
MODULI

Cassettiera 4 cassetti (vuota)

- Per carrelli Racing 519 R a 4 moduli
- 3 cassetti: 760x420x60 mm
- 1 cassetto: 760x420x130 mm

~~€ 848,00~~

€ 594,00



519 R4/5V

Cod. U05190412

4
CASSETTI

5
MODULI

Cassettiera 4 cassetti (vuota)

- Per carrelli Racing 519 R a 5 moduli
- 3 cassetti: 950x420x60 mm
- 1 cassetto: 950x420x130 mm

~~€ 957,00~~

€ 670,00



NUOVO CARRELLO SPRINT 518

**PIANO DI LAVORO IN ABS CON
DOPPIA MANIGLIA INTEGRATA**

900 KG

NEW

SERRATURA POSTERIORE
per evitare rotture accidentali



**GUIDE CON SISTEMA DI
RICHIAMO A FINE CORSA**
Tenuta del cassetto rinforzata

**MANIGLIE CASSETTI
FISSE IN ALLUMINIO
ANODIZZATO**

Design a doppia T per la presa dall'alto o dal basso



PORTA FLACONI



RUOTE

in gomma antiolio (Ø 125 mm)

SPRINT 518



518 SP6V
Cod. U05180106

6

CASSETTI

3

MODULI

Carrello SPRINT (vuoto)

- Dimensioni interne:
 - 4 cassetti 570x420x60 mm
 - 1 cassetti 570x420x130 mm
 - 1 cassetto 570x420x270 mm

~~€ 700,00~~

€ 490,00

NEW



518 SP7V
Cod. U05180107

7

CASSETTI

3

MODULI

Carrello SPRINT (vuoto)

- Dimensioni interne:
 - 5 cassetti 570x420x60 mm
 - 1 cassetti 570x420x130 mm
 - 1 cassetto 570x420x200 mm

~~€ 790,00~~

€ 540,00

NEW

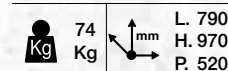
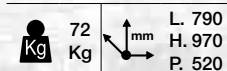



200 KG



504 S

Cod. U05040003

3

RIPIANI

Carrello multiuso

- Ripiani protetti con materiale plastico ad alta resistenza
- Maniglia in acciaio per una maggiore manovrabilità
- Due ruote pivottanti (Ø 100 mm) e due ruote fisse (Ø 100 mm)
- Fornito smontato

~~€ 159,00~~

€ 115,00

1100 KG

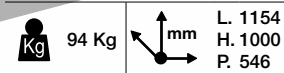

513 B6V

Cod. U05130096

6

CASSETTI

3

MODULI

Carrello Booster (vuoto)

- Armadietto portaoggetti con anta richiudibile
- Ruote in gomma antiolio (Ø 160 mm)
- Dimensioni interne:
 - 4 cassette 570x420x60 mm
 - 1 cassetto 570x420x130 mm
 - 1 cassetto 570x420x270 mm
- Vano laterale: 380x400x720 mm

~~€ 1.443,00~~

€ 1.010,00

1100 KG

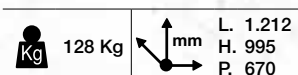

514 B6V

Cod. U05140001

6

CASSETTI

3

MODULI

Banco da lavoro mobile BULL (vuoto)

- Piano di lavoro in legno multistrato
- Portata massima cassette: 20 Kg
- Dimensioni interne:
 - 3 cassette 570x420x60 mm
 - 2 cassette 570x420x130 mm
 - 1 cassetto 570x420x270 mm
- Vano laterale: 380x704x524 mm

~~€ 1.834,00~~

€ 1.284,00

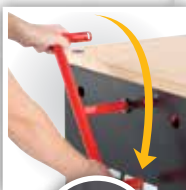

ACCESSORI CARRELLI



519 RA1

Cod. U05190207

Portarifiuti

per Racing, Sprint, Start, Booster e Bull

~~€ 85,50~~

€ 60,00



519 RA2

Cod. U05190208

Portadocumenti

per Racing, Sprint, Start, Booster e Bull

~~€ 47,40~~

€ 33,00



519 RA3

Cod. U05190209

Pannello superiore

per Racing (3 moduli)

€ 135,00

€ 94,50



519 RA4

Cod. U05190210

Portarotolo

per Racing, Sprint, Start, Booster e Bull

~~€ 48,70~~

€ 34,00



519 RA5

Cod. U05190211

Portaflaconi

per Racing, Sprint, Start, Booster e Bull

~~€ 75,00~~

€ 52,50



519 M 127N
Cod.U05190937 **4 PEZZI**

127 N 19÷60 · 127 PN 19÷60 ·
128 N 19÷60 · 128 PN 19÷60

€ 95,50 € 67,00



519 M 150AX
Cod.U05190965 **5 PEZZI**

133 AX 160 · 134 250 · 150 AX 180 ·
180 C 250 · 188 AX 160

€ 141,80 € 99,50

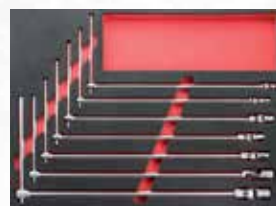

519 M 276
Cod.U05190936 **7 PEZZI**

276 CE 7-8-10-11-13-17-19

€ 219,00 € 153,00



519 M 280HA
Cod.U05190945 **7 PEZZI**

280 HA 3-4-5-6-7-8-10

€ 68,40 € 48,00



519 M 280HATS
Cod.U05190946 **7 PEZZI**

280 HATS 3-4-5-6-7-8-10

€ 73,50 € 51,50



519 M 280HATX
Cod.U05190947 **7 PEZZI**

280 HATX T10-T15-T20-T25-T27-T30-T40

€ 68,40 € 48,00

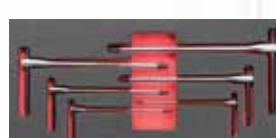

519 M 280TK
Cod.U05190935 **6 PEZZI**

280 TK 2,5-3-4-5-6-8

€ 99,50 € 69,50



519 M 285A1
Cod.U05190921 **17 PEZZI**

285 6-7-8-9-10-11-12-13-14-15-16-
17-18-19-21-22-24

€ 155,80 € 109,00



519 M 285A2
Cod.U05190943 **5 PEZZI**

285 27-29-30-32-34

€ 125,00 € 89,00



519 M 285KA
Cod.U05190944 **12 PEZZI**

285 KA 8-9-10-11-12-13-14-15-
16-17-18-19

€ 210,00 € 147,00



519 M 285KF
Cod.U05190964 **12 PEZZI**

285 KF 8-9-10-11-12-13-14-
15-16-17-18-19

€ 246,50 € 173,00



519 M 324H
Cod.U05190922 **8 PEZZI**

324 0,5x3x75-0,6x3,5x100-0,8x4x100-
1x5,5x125-1,2x6,5x150-1,6x8x175
324 PH 1x100-2x125

€ 61,00 € 42,50



519 M 324STX
Cod.U05190923 **7 PEZZI**

324 STX T10x75-T15x75-T20x100-
T25x100-T27x100-T30x125-T4x150

€ 90,50 € 63,50



519 M 382F
Cod.U05190926 **7 PEZZI**

362 175 · 367 4x145-5x165-6x180
368 5x150 · 376 35 · 382F 500

€ 89,00 € 62,50



519 M 613AEA **45 PEZZI**

Cod.U05190940 (237 A)

235 1/4" EN 5,5-6-7-8-9-10-11-12-13-
14 · 236 1/4" 50-100 · 240 1/4" · 241
1/4" · 243 1/4" · 280 LTS/S9 · 684 1/4"-
1/4" · 660 0,6-1-1,6 · 660 E 3-4-5-6-8
660 PH 1-2-3 · 660 PZ 1-2-3 · 660 STX
T20-T25-T27-T30-T40

€ 205,00 € 144,00



519 M 613AEB **45 PEZZI**

Cod.U05190924 (237 B)

235 1/4" EN 5,5-6-7-8-9-10-11-12-13-14
· 236 1/4" 50-100 · 240 1/4" · 241 1/4" ·
243 1/4" · 280 LTS/S9 · 684 1/4"-1/4" ·
660 0,6-1-1,6 · 660 E 3-4-5-6-8 660 PH
1-2-3 · 660 PZ 1-2-3 · 660 STX T20-T25-
T27-T30-T40

€ 210,00 € 147,00



519 M 613BEA **20 PEZZI**

Cod.U05190928 (237 A)

235 3/8" E 7-8-9-10-11-12-13-14-15-16-
17-18-19-21-22 · 236 3/8" 125-250
240 3/8" N · 241 3/8"

€ 177,00 € 124,00



519 M 613BEB **20 PEZZI**

Cod.U05190941 (237 B)

235 3/8" E 7-8-9-10-11-12-13-14-
15-16-17-18-19-21-22 · 236 3/8" 125-
250 · 240 3/8" N · 241 3/8"

€ 183,00 € 128,00



519 M 613CEA **23 PEZZI**

Cod.U05190942 (237 A)

235 1/2" EN 8-10-11-12-13-14-15-16-17-
18-19-21-22-23-24-27-30-32 236 1/2"
125-250 · 240 1/2" N · 241 1/2"

€ 222,00 € 155,00



519 M 613CEB **23 PEZZI**

Cod.U05190925 (237 B)

235 1/2" EN 8-10-11-12-13-14-15-16-17-
18-19-21-22-23-24-27-30-32 236 1/2"
125-250 · 240 1/2" N · 241 1/2"

€ 231,00 € 162,00

IN SPUGNA BICOLORE

NEW



**VISUALIZZAZIONE IMMEDIATA
DEGLI UTENSILI MANCANTI**

**MODULARI CON I CASSETTI
DEI CARRELLI USAG**



519 M 127N



519 M 150AX



519 M 324H



519 M 613AEA



519 M 613CEA



519 M 285A1



519 M 276

495 MMA
Cod. U04958003

109
PEZZI



Assortimento AUTO - 3 cassettei

~~€ 1.104,00~~

€ 773,00

DESCRIZIONE	ART	PZ
Pinze per anelli elastici	519 M 127N	4
Pinza universale, pinza regolabile, tronchese, pinza becchi lunghissimi, pinza grip	519 M 150AX	5
Chiavi a T snodate esagonali	519 M 276	7
Chiavi combinate	519 M 285A1	17
Giraviti a taglio e croce PH	519 M 324H	8
Bussole esagonali, cricchetto (237 A 1/4"), accessori 1/4" ed inserti	519 M 613AEA	45
Bussole esagonali, cricchetto (237 A 1/2") e accessori 1/2"	519 M 613CEA	23



519 M 127N



519 M 150AX



519 M 324H



519 M 613AEA



519 M 613CEA



519 M 285A1



519 M 324H



519 M 324STX



519 M 280TK

495 MMI
Cod. U04958004

122
PEZZI



Assortimento INDUSTRIA - 3 cassettei

~~€ 1.197,00~~

€ 838,00

DESCRIZIONE	ART	PZ
Pinze per anelli elastici	519 M 127N	4
Pinza universale, pinza regolabile, tronchese, pinza becchi lunghissimi, pinza grip	519 M 150AX	5
Chiavi maschio a T con traversino scorrevole	519 M 280TK	6
Chiavi combinate	519 M 285A1	17
Giraviti a taglio e croce PH	519 M 324H	8
Giraviti TORX® Tamper Resistant	519 M 324STX	7
Martelli, scalpelli e cacciaspine	519 M 382F	7
Bussole esagonali, cricchetto (237 A 1/4"), accessori 1/4" ed inserti	519 M 613AEA	45
Bussole esagonali, cricchetto (237 A 1/2") e accessori 1/2"	519 M 613CEA	23

MODULI IN PLASTICA



519 SKV6
Cod.U05190827
Vaschetta portaminuterie
~~€ 11,40~~ **€ 8,00**



519 SK692V
Cod.U05190832
Vaschetta portaminuterie
~~€ 11,40~~ **€ 8,00**



519/092H
Cod.U05190771 **9 PEZZI**
092 0,4x2,5x50-0,5x3x75 0,6x3,5x100-
0,8x4x100-1x5,5x125-1,2x6,5x150 ·
092 PH 0x75-1x100-2x125
~~€ 72,50~~ **€ 51,00**



519/127N
Cod.U05190716 **4 PEZZI**
127 N 19÷60 · 127 PN 19÷60 ·
128 N 19÷60 · 128 PN 19÷60
~~€ 91,00~~ **€ 63,50**



519/134
Cod.U05190830 **2 PEZZI**
134 250 · 180 B 250
~~€ 66,20~~ **€ 46,50**



519/150AX
Cod.U05190850 **5 PEZZI**
133 AX 160 · 134 250 · 150 AX 180 ·
180 C 250 · 188 AX 160
~~€ 137,50~~ **€ 96,50**



519/200I
Cod.U05190715 **11 PEZZI**
200 S · 207 A · 362 125-150 · 364 125
366 3x125-4x150 · 368 4x125 · 376 35 ·
382 500 · 966 20
~~€ 134,00~~ **€ 94,00**



519/233A
Cod.U05190820 **15 PEZZI**
233 1/2 NS 9L-10L · 233 1/2" NTX T40L-
T45L-T55L-T70L · 233 1/2 NXZN 6L-8L-
10L-12L-14L · 234 1/2 N 5L2-6L-7L-8L
~~€ 237,00~~ **€ 166,00**



519/234C
Cod.U05190720 **22 PEZZI**
233 1/2" NTX T27-T30-T40-T45-T50-
T55-T60 · 234 1/2" N 5-6-7-8-10-12-
14-17 · 235 1/2" NTX E10-E12-E14-E16-
E18-E20-E24
~~€ 224,00~~ **€ 157,00**



519/235LN
Cod.U05190829 **10 PEZZI**
235 1/2 LN 10-11-12-13-14-15-16-17-
19-22
~~€ 139,80~~ **€ 98,00**



519/235M
Cod.U05190719 **21 PEZZI**
235 1/2 M 10-11-12-13-14-15-16-17-18-
19-22-24 325 1/2 MLS 15-17-19-21-22
235 MC 4-5 235 MD 4-5
~~€ 112,00~~ **€ 78,50**



519/252A1
Cod.U05190821 **11 PEZZI**
252 N 6x7-8x9-10x11-12x13-14x15-
16x17-18x19-21x23-22x24-27x29-30x32
~~€ 94,28~~ **€ 66,00**



519/276
Cod.U05190725 **8 PEZZI**
276 CE 7-8-10-11-13-14-17-19
~~€ 237,00~~ **€ 166,00**



519/280HA
Cod.U05190860 **7 PEZZI**
280 HA 3-4-5-6-7-8-10
~~€ 64,10~~ **€ 45,00**



519/280HATS
Cod.U05190861 **7 PEZZI**
280 HATS 3-4-5-6-7-8-10
~~€ 69,20~~ **€ 48,50**



519/280HATX
Cod.U05190862 **7 PEZZI**
280 HATX T10-T15-T20-T25-T27-T30-T40
~~€ 64,10~~ **€ 45,00**



519/280T
Cod.U05190727 **8 PEZZI**
280 T 2-2,5-3-4-5-6-8-10
~~€ 132,00~~ **€ 92,50**



519/280TK
Cod.U05190787 **6 PEZZI**
280 TK 2,5-3-4-5-6-8
~~€ 94,50~~ **€ 66,00**



519/283A1
Cod.U05190822 **8 PEZZI**
283 N 6x7-8x9-8x10-10x11-12x13-
14x15-16x17-18x19
~~€ 81,29~~ **€ 57,00**



519/285A1
Cod.U05190785 **25 PEZZI**
285 6-7-8-9-10-11-12-13-14-15-16-17-
18-19-22-24 280 S9 1,5÷10
~~€ 159,00~~ **€ 111,00**



519/285B2
Cod.U05190823 **4** PEZZI
285 27-29-30-32
€ 89,40 € 62,50



519/285KA1
Cod.U05190788 **12** PEZZI
285 KA 8-9-10-11-12-13-14-15-16-17-18-19
€ 201,00 € 141,00



519/285KF
Cod.U05190851 **12** PEZZI
285 KF 8-9-10-11-12-13-14-15-16-17-18-19
€ 242,20 € 170,00



519/291NA
Cod.U05190824 **10** PEZZI
291 N 8-10-11-12-13-14-16-17-18-19
€ 165,60 € 116,00



519/294
Cod.U05190732 **9** PEZZI
204 250 · 294 A 250 · 367 2x110-3x130-4x145-5x165-6x180-8x200 · 981 A2
€ 101,00 € 70,50



519/299
Cod.U05190777 **5** PEZZI
299 6-7-8-10-13 mm
€ 76,50 € 53,50



519/322H
Cod.U05190772 **10** PEZZI
322 0,5x3x75-0,8x4x100-1x5,5x125-1,2x6,5x150-1,6x8x175 · 322 PH 0x75-1x100-2x125 · 322 N 0,8x4x30 · 322 NPH 2x30
€ 49,70 € 35,00



519/322STX
Cod.U05190831 **6** PEZZI
322 STX T10-T15-T20-T25-T30-T40
€ 47,95 € 33,50



519/324B
Cod.U05190776 **11** PEZZI
324 0,5x3x75-0,8x4x100-1x5,5x125-1,2x6,5x150 · 324 PH 1x75-2x100 · 324 N 0,8x4x35 · 324 NPH 2x35 · 092 0,8x4x100 · 092 PH 1x100 · 322 F
€ 78,00 € 54,50



519/324H
Cod.U05190774 **10** PEZZI
324 0,5x3x75-0,8x4x100-1x5,5x125-1,2x6,5x150-1,2x8x200 · 324 PH 0x75-1x75-2x100 · 324 N 0,8x4x35 · 324 NPH 2x35
€ 63,50 € 44,50



519/324TX
Cod.U05190775 **9** PEZZI
324 TX T6x50-T7x50-T8x50-T9x75 · 324 STX T10x75-T15x75-T20x100-T25x100-T30x125
€ 91,00 € 63,50



519/366
Cod.U05190740 **7** PEZZI
351 200 · 362 125-150 · 364 125 · 366 3x125 · 4x150 · 368 4x125
€ 64,00 € 45,00



519/382
Cod.U05190741 **2** PEZZI
376 35 · 382 500
€ 36,40 € 27,00



519/382F
Cod.U05190742 **8** PEZZI
362 150 · 367 2x110-3x130-4x145-5x165 · 368 4x125 · 376 35 · 382F 500
€ 82,50 € 57,50



519/382FA
Cod.U05190828 **8** PEZZI
362 150 · 367 2x100-3x130-4x145-5x165 · 368 4x125 · 376 F 32 · 382 F 500
€ 86,92 € 61,00



519/607ACEA  **56** PEZZI
Cod.U05190839 (237 A)
235 1/2 EN 10-11-12-13-14-15-16-17-18-19-21-22-24-27-30-32 · 235 1/4 EN 5,5-6-7-8-9-10-11-12-13-14 · 236 1/2 125 · 236 1/4 50-100 · 237 A 1/2 · 237 A 1/4 · 241 1/2 · 241 1/4 · 243 1/4 · 660 0,8x5,5-1x5,5-1,2x6,5 · 660 E 3-4-5-6-8 · 660 PH 1-2-3 · 660 PZ 1-2-3 · 660 STX T10-T15-T20-T25-T27-T30-T40 · 684
€ 340,76 € 239,00



519/607ACEB  **56** PEZZI
Cod.U05190840 (237 B)
235 1/2 EN 10-11-12-13-14-15-16-17-18-19-21-22-24-27-30-32 · 235 1/4 EN 5,5-6-7-8-9-10-11-12-13-14 · 236 1/2 125 · 236 1/4 50-100 · 237 B 1/2 · 237 B 1/4 · 241 1/2 · 241 1/4 · 243 1/4 · 660 0,8x5,5-1x5,5-1,2x6,5 · 660 E 3-4-5-6-8 · 660 PH 1-2-3 · 660 PZ 1-2-3 · 660 STX T10-T15-T20-T25-T27-T30-T40 · 684
€ 356,36 € 249,00



519/607AEA  **44** PEZZI
Cod.U05190790 (237 A)
235 1/4" EN 4÷14 · 235 1/4" EL 5÷14 · 236 1/4" 50-100-150 · 240 1/4" · 241 1/4" · 243 C 1/4" · 660 · 660 E · 660 PH · 684 1/4"-1/4" · 236 1/4" SN
€ 251,00 € 176,00



519/607AEB  **44** PEZZI
Cod.U05190791 (237 B)
235 1/4" EN 4÷14 · 235 1/4" EL 5÷14 · 236 1/4" 50-100-150 · 240 1/4" · 241 1/4" · 243 C 1/4" · 660 · 660 E · 660 PH · 684 1/4"-1/4" · 236 1/4" SN
€ 256,00 € 179,00



519/607CA  **30** PEZZI
Cod.U05190810 (237 A)
235 1/2" N 8÷34 · 236 1/2" 125-250 · 239 1/2" N · 240 1/2" N · 241 1/2"
€ 282,00 € 197,00

MODULI IN PLASTICA



519/607CB ● **30**
Cod.U05190812 (237 B) **PEZZI**

235 1/2" N 8÷34 · 236 1/2" 125-250 ·
239 1/2" N · 240 1/2" N · 241 1/2"

€ 292,00 € 204,00



519/607CEA ● **30**
Cod.U05190811 (237 A) **PEZZI**

235 1/2" N 8÷34 · 236 1/2" 125-250 ·
239 1/2" N · 240 1/2" N · 241 1/2"

€ 283,00 € 198,00



519/607CEB ● **30**
Cod.U05190813 (237 B) **PEZZI**

235 1/2" EN 8÷34 · 236 1/2" 125-250 ·
239 1/2" N · 240 1/2" N · 241 1/2"

€ 284,00 € 199,00



519/607ICEA ● **49**
Cod.U05190841 (237 A) **PEZZI**

235 1/2 EN 8-10-11-12-13-14-15-16-17-
18-19-21-22-23-24-27-30-32 · 236 1/2
125-250 · 237 A 1/2 · 240 1/2 N · 241 1/2
· 661 0,8x5,5-1x6,5-1,2x8-1,6x10 · 661 E
5-6-8-10 · 661 PH 1-2-3 · 661 PZ 1-2-3 ·
661 TX T27-T30-T40-T45-T50-T55 · 664
EL 5-6-7-8-10 · 684 1/2-5/16

€ 332,46 € 233,00



519/607ICEB ● **49**
Cod.U05190842 (237 B) **PEZZI**

235 1/2 EN 8-10-11-12-13-14-15-16-17-
18-19-21-22-23-24-27-30-32 · 236 1/2
125-250 · 237 B 1/2 · 240 1/2 N · 241 1/2
· 661 0,8x5,5-1x6,5-1,2x8-1,6x10 · 661 E
5-6-8-10 · 661 PH 1-2-3 · 661 PZ 1-2-3 ·
661 TX T27-T30-T40-T45-T50-T55 · 664
EL 5-6-7-8-10 · 684 1/2-5/16

€ 342,26 € 240,00



519/613AEA ● **42**
Cod.U05190784 (237 A) **PEZZI**

235 1/4" EN 4-4,5-5-5,5-6-7-8-9-10-
11-12-13-14 · 236 1/4" 50-150 · 240
1/4" · 241 1/4" · 243 C 1/4" · 692 S11 ·
692 STX/S11 · 684 1/4"-1/4"

€ 176,00 € 123,00



519/613AEB ● **42**
Cod.U05190778 (237 B) **PEZZI**

235 1/4" EN 4-4,5-5-5,5-6-7-8-9-10-
11-12-13-14 · 236 1/4" 50-150 · 240
1/4" · 241 1/4" · 243 C 1/4" · 692 S11 ·
692 STX/S11 · 684 1/4"-1/4"

€ 180,00 € 126,00



519/613BEA ● **21**
Cod.U05190747 (237 A) **PEZZI**

235 3/8" E 6-7-8-9-10-11-12-13-14-15-
16-17-18-19-21-22 · 236 3/8" 125-250 ·
240 3/8" N · 241 3/8"

€ 181,00 € 127,00



519/613BEB ● **21**
Cod.U05190779 (237 B) **PEZZI**

235 3/8" E 6-7-8-9-10-11-12-13-14-15-
16-17-18-19-21-22 · 236 3/8" 125-250 ·
240 3/8" N · 241 3/8"

€ 189,00 € 132,00



519/613CEA ● **22**
Cod.U05190750 (237 A) **PEZZI**

235 1/2" EN 10-11-12-13-14-15-16-17-
18-19-20-21-22-24-27-30-32 · 236 1/2"
125-250 · 240 1/2" N · 241 1/2"

€ 218,00 € 153,00



519/613CEB ● **22**
Cod.U05190780 (237 B) **PEZZI**

235 1/2" EN 10-11-12-13-14-15-16-17-
18-19-20-21-22-24-27-30-32 · 236 1/2"
125-250 · 240 1/2" N · 241 1/2"

€ 227,00 € 159,00



519/613CB ● **22**
Cod.U05190783 (237 B) **PEZZI**

235 1/2" E 10-11-12-13-14-15-16-17-18-
19-20-21-22-24-27-30-32 · 236 1/2"
125-250 · 240 1/2" N · 241 1/2"

€ 227,00 € 159,00



519/615AEA ● **52**
Cod.U05190837 (237 A) **PEZZI**

235 1/4 EN 5,5-6-7-8-9-10-11-12-13-14
· 236 1/4 50-150 · 237 A 1/4 · 240 1/4
· 241 1/4 · 243 1/4 · 280 LTS/S9 · 280
LTSTX/S8 · 660 E 3-4-5-6-8 · 660 PH
1-2-3 · 660 PZ 1-2 · 660 STX T10-T15-
T20-T25-T30-T40 · 684 1/4

€ 243,19 € 170,00



519/615AEB ● **52**
Cod.U05190838 (237 B) **PEZZI**

235 1/4 EN 5,5-6-7-8-9-10-11-12-13-14
· 236 1/4 50-150 · 237 B 1/4 · 240 1/4
· 241 1/4 · 243 1/4 · 280 LTS/S9 · 280
LTSTX/S8 · 660 E 3-4-5-6-8 · 660 PH
1-2-3 · 660 PZ 1-2 · 660 STX T10-T15-
T20-T25-T30-T40 · 684 1/4

€ 243,19 € 170,00



519/960 **7**
Cod.U05190753 **PEZZI**

207 A · 220 B1 · 960 · 966 20 · 974 ·
978 A 200 · 981 C 3

€ 126,00 € 88,00



519/990A1 **4**
Cod.U05190825 **PEZZI**

990 M PA/200 · 990 M PB/200
990 M PC/200 · 990 M PE/200

€ 49,13 € 34,50



519/990AB1 **4**
Cod.U05190826 **PEZZI**

990 B PA/200 · 990 B PB/200
990 B PC/200 · 990 B PE/200

€ 48,30 € 34,00



519/127N



519/150AX



519/285A1



519/324H



519/382F



519/613CEA



519/127N



519/150AX



519/276



519/285A1



519/324H



519/324TX



519/613CEA



519/127N



519/150AX



519/200I



519/285A1



519/294



519/324H



519/613CEA

495 BA

Cod. U04950002

74
PEZZI

Assortimento manutenzione BASE - 2 cassette

~~€ 757,00~~
€ 530,00

DESCRIZIONE	ART	PZ
Pinze per anelli elastici	519/127N	4
Pinza universale, pinza regolabile, tronchese, pinza becchi lunghissimi, pinza grip	519/150AX	5
Chiavi combinate, chiavi maschio esagonali	519/285A1	25
Giraviti	519/324H	10
Martello, mazzuola, scalpello, bulino, cacciaspine	519/382F	8
Bussole esagonali, cricchetto (237 A 1/2") e accessori 1/2"	519/613CEA	22

495 A1

Cod. U04950011

83
PEZZI

Assortimento AUTO - 3 cassette

~~€ 1.019,00~~
€ 713,00

DESCRIZIONE	ART	PZ
Pinze per anelli elastici	519/127N	4
Pinza universale, pinza regolabile, tronchese, pinza becchi lunghissimi, pinza grip	519/150AX	5
Chiavi a T snodate esagonali	519/276	8
Chiavi combinate, chiavi maschio esagonali	519/285A1	25
Giraviti a taglio e croce PH	519/324H	10
Giraviti TORX	519/324TX	9
Bussole esagonali, cricchetto (237 A 1/2") e accessori 1/2"	519/613CEA	22

495 I1

Cod. U04950021

86
PEZZI

Assortimento INDUSTRIA - 3 cassette

~~€ 920,00~~
€ 644,00

DESCRIZIONE	ART	PZ
Pinze per anelli elastici	519/127N	4
Pinza universale, pinza regolabile, tronchese, pinza becchi lunghissimi, pinza grip	519/150AX	5
Taglio, martelli, scalpelli	519/200I	11
Chiavi combinate, chiavi maschio esagonali	519/285A1	25
Chiave a rullino, cesoia, flessometro e cacciaspine	519/294	9
Giraviti a taglio e croce PH	519/324H	10
Bussole esagonali, cricchetto (237 A 1/2") e accessori 1/2"	519/613CEA	22

GAMMA PINZE "AX": IL TOP DELLE PERFORMANCE

FINITURA CROMATA. IMPUGNATURE BIMATERIALE.

150 AX

NEW

TAGLIENTI TEMPRATI AD INDUZIONE
per la massima efficacia nel taglio del filo armonico

FULCRO PIÙ VICINO AI TAGLIENTI
per il minimo sforzo durante il taglio



**Taglia fino a Ø 2 mm di filo armonico
con il 30% in meno di forza**
rispetto al valore massimo
indicato dalle normative europee
ISO5749 (tronchesi) - ISO5746 (pinze)

**NUOVA
IMPUGNATURA USAG**

**PRODOTTI
SUL MERCATO**

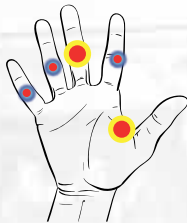
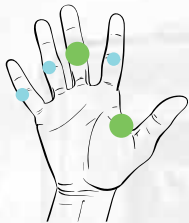

- SFORZO

+ SFORZO

Minimo sforzo risultante dagli studi
sugli sforzi muscolari effettuati
dal prestigioso istituto americano US Ergonomics

**ASOLA
DI AGGANCIO**

**IMPUGNATURE ERGONOMICHE
BIMATERIALE**



131 AX

133 AX

185 AX

188 AX

182 AX

114 AX

147 AX



150 AX/SE3

Cod. U01500201

3
PEZZI

Assortimento con pinza universale, pinza a becchi mezzotondi diritti e tronchese a tagliente diagonale

- Pinza universale 150 AX 180
- Pinza a becchi mezzotondi lunghissimi diritti 133 AX 160
- Tronchese a grande effetto a tagliente diagonale 188 AX 160

~~€ 81,00~~

€ 56,00



150 AX/SE2

Cod. U01500200

2
PEZZI

Assortimento con pinza universale e tronchese a tagliente diagonale

- Pinza universale 150 AX 180
- Tronchese a grande effetto a tagliente diagonale 188 AX 160

~~€ 53,00~~

€ 38,00



150 AX/SP2

Cod. U01500202

2
PEZZI

Assortimento con pinza universale e pinza regolabile

- Pinza universale 150 AX 180
- Pinza regolabile a cerniera chiusa 180 C 250

~~€ 55,20~~

€ 38,00

GAMMA PINZE "CX": LA QUALITÀ NELLE TUE MANI

FINITURA VERNICIATA. IMPUGNATURE IN PVC.



150 CX

TAGLIENTI TEMPRATI AD INDUZIONE
per la massima efficacia nel taglio del filo armonico



**FULCRO PIÙ VICINO
AI TAGLIENTI**
per il minimo sforzo
durante il taglio

**IMPUGNATURE
IN PVC STAMPATO**



131 CX

133 CX

185 CX

188 CX

182 CX



NEW

150 CX/SE3

Cod. U01500211

3

PEZZI

Assortimento con pinza universale, pinza a becchi mezzotondi diritti e tronchese a tagliente diagonale

- Pinza universale 150 CX 180
- Pinza a becchi mezzotondi lunghissimi diritti 133 CX 160
- Tronchese a grande effetto a tagliente diagonale 188 CX 160

~~€ 68,00~~**€ 48,00**

NEW

150 CX/SE2

Cod. U01500210

2

PEZZI

Assortimento con pinza universale e tronchese a tagliente diagonale

- Pinza universale 150 CX 180
- Tronchese a grande effetto a tagliente diagonale 188 CX 160

~~€ 45,00~~**€ 32,00**

NEW

150 CX/SP2

Cod. U01500212

2

PEZZI

Assortimento con pinza universale e pinza regolabile

- Pinza universale 150 CX 180
- Pinza regolabile a cerniera sovrapposta 178 N 250

~~€ 45,70~~**€ 32,00**

PINZA REGOLABILE SEMIAUTOMATICA A CERNIERA CHIUSA

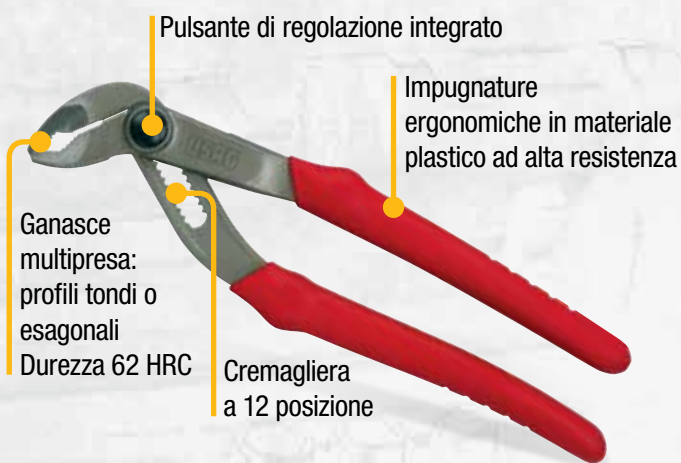

42 mm

180 B

Cod. U01800031

~~€ 38,90~~ **€ 27,00**

30 mm



41 mm

42 mm

180 BL

Cod. U01800035

~~€ 40,70~~ **€ 28,50**

40 mm



41 mm



39 mm

180 C 250

Cod. U01800010

~~€ 29,20~~ **€ 20,50**

36 mm

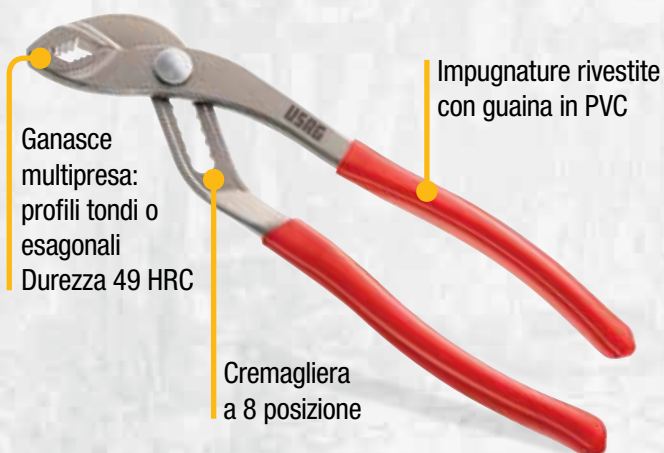

44 mm

178 N 250

Cod. U01780012

~~€ 22,40~~ **€ 15,00**

44 mm

30 mm

178 N 180

Cod. U01780011

~~€ 17,30~~ **€ 12,10**

30 mm



CERNIERA CHIUSA

Garantisce la massima stabilità nella presa e la trasmissione ottimale della forza



CERNIERA SOVRAPPOSTA

Permette una presa sicura per la maggior parte delle applicazioni



**SISTEMA DI APERTURA
INNOVATIVO BREVETTATO**



135 A

Cod. U01350505

MAX Ø
80
mm

Pinza regolabile autobloccante a cremagliera con ganasce corte

- Ganasce forgiate
- Dentatura studiata per una presa perfetta anche su tondo
- Sistema di apertura brevettato ed integrato nei manici
- Rullino di regolazione della presa integrato sul manico superiore
- Cremagliera a 5 posizioni

~~€ 58,50~~

€ 41,00

135 B

Cod. U01350510

MAX Ø
110
mm

Pinza regolabile autobloccante a cremagliera con ganasce lunghe

- Ganasce forgiate
- Dentatura studiata per una presa perfetta anche su tondo
- Sistema di apertura brevettato ed integrato nei manici
- Rullino di regolazione della presa integrato sul manico superiore
- Cremagliera a 5 posizioni

~~€ 63,50~~

€ 44,50



127 N/SE4

Cod. U01279000P

4
PEZZI

Serie 4 pinze per anelli elastici

- Pinze per anelli elastici interni 127 N 19÷60-127 PN 19÷60
- Pinze per anelli elastici esterni 128 N 19÷60-128 PN 19÷60

~~€ 85,50~~

€ 60,00



1000 V

085 N/S2
Cod. U00859000P



2
PEZZI

Assortimento con pinza universale e tronchese diagonale

- Pinza universale **085 N 180**
- Tronchese taglio diagonale **087 N 160**

~~€ 70,00~~

€ 49,00



1000 V

092 SH5
Cod. U00920100



5
PEZZI

Serie di 5 giraviti per viti con intaglio e per viti con impronta a croce PHILLIPS®

- 092/0,5x3x75-0,8x4x100-1x5,5x125
- 092 PH/1x100-2x125

~~€ 39,00~~

€ 29,00



1000 V

092 D/SH5
Cod. U00920119



5
PEZZI

Serie di 5 giraviti SLIM per viti con intaglio e per viti con impronta a croce PHILLIPS®

- 092 D/0,6x3,5x100-0,6x4x100-1x5,5x125
- 092 DPH/1x100-2x125

~~€ 46,70~~

€ 34,50

USAG SLIM

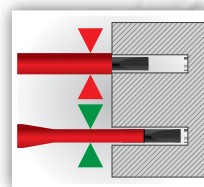

1000 V

092 DPHB/SE2
Cod. U00920122



2
PEZZI

Serie di 2 giraviti SLIM per viti con impronta combinata intaglio / PHILLIPS®

- 092 DPHB/1x100-2x125

~~€ 20,00~~

€ 14,80

USAG SLIM



324 SH12

Cod. U03240251



12
PEZZI

Serie di 12 giraviti per viti con intaglio, impronta a croce PHILLIPS® e impronta a croce POZIDRIV® - SUPADRIV®

- 324 D/0,4x2,5x50
- 324/0,5x3x75-0,8x4x100-1x5,5x125-1,2x6,5x150
- 324 N/1x5,5x35
- 324 PH/0x75-1x75-2x100
- 324 NPH/2x35
- 324 PZ/1x75-2x100

~~€ 70,00~~

€ 46,00



Punta Fosfatata



324 SH8

Cod. U03240250



8
PEZZI

Serie di 8 giraviti per viti con intaglio e impronta a croce PHILLIPS®

- 324 D/0,4x2,5x50
- 324/0,5x3x75-0,8x4x100-1x5,5x125-1,2x6,5x150
- 324 PH/0x75-1x75-2x100

~~€ 41,20~~

€ 27,00



Punta Fosfatata



324 STX/S7

Cod. U03240093



7
PEZZI

Serie di 7 giraviti con impronta TORX® Tamper Resistant

- 324 STX T10x75-T15x75-T20x100-T25x100-T27x100-30x125-T40x150

~~€ 80,50~~

€ 56,50



Punta Fosfatata



322 SH10

Cod. U03220255



10
PEZZI

Serie di 10 giraviti per viti con intaglio e impronta a croce PHILLIPS®

- 322 0,4x2x50-0,5x3x75-0,8x4x100-1x5,5x100-1,2x6,5x150
- 322 PH/0X75-1x100-2x125
- 322 PZ 1X100-2X125

~~€ 42,80~~

€ 30,00

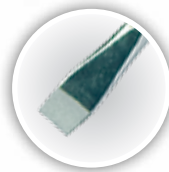

Punta
sabbata



341 SH6

Cod. U03410018

6
PEZZI

Serie di 6 giraviti di precisione per viti con intaglio ed impronta a croce PHILLIPS®

- Impugnatura monomateriale ergonomica
- Lame in acciaio con finitura cromata
- Fornito in cassetta di plastica

~~€ 21,80~~

€ 15,30

⊕ PH00-PH000 ⊖ 1-1,2-1,5-1,8 mm

Kg	0,2 Kg	mm	L. 135
			H. 195
			P. 25



341 SH33

Cod. U03410019

33
PEZZI

Giravite di precisione portainseriti con 32 inserti

- Impugnatura monomateriale ergonomica
- Fornito in cassetta di plastica

~~€ 33,50~~

€ 23,50

- ⊖ 1-1,2-1,5-1,8-2-2,5-3 mm
- ⊕ PH0-PH00-PH000
- ⊗ T5-T6-T7-T8-T9
- ⊗ TT10-TT15-TT20
- ⊕ PZ0-PZ1
- 0,9-1,3-1,5-2-2,5-3-4 mm
- ⊕ PT2-PT3-PT4
- ⊖ PT0-PT1

Kg	0,2 Kg	mm	L. 135
			H. 195
			P. 25



Just **USAG**



Kg 0,3 Kg L. 138
H. 30
P. 98

692 J32
Cod. U06920042

1/4 **32**
PEZZI

Assortimento di inserti con cricchetto

~~€ 45,70~~ **€ 31,00**

DESCRIZIONE	MISURA		PZ.
Inserti ad intaglio	4-5,5-6,5-8	⊖	4
Inserti a croce Phillips®	PH 1-2-3	⊕	3
Inserti a croce Pozidriv®	PZ 1-2-3	⊕	3
Inserti esagono maschio	3-4-5-6	⊙	4
Inserti TORX®	T8-10-15-20-20-25-25-30-40	⊗	9
Inserti TORX® Tamper Resistant	STX 10-15-20-25-27-30-40	⊗	7
Portainseri magnetico			1
Cricchetto			1



Kg 0,3 Kg L. 138
H. 30
P. 98

692 J49
Cod. U06920041

1/4 **49**
PEZZI

Assortimento di inserti

~~€ 35,30~~ **€ 26,00**

DESCRIZIONE	MISURA		PZ.
Inserti ad intaglio	4-4,5-5,5-6,5-6,5-8	⊖	6
Inserti a croce Phillips®	PH 1-1-2-2-2-3	⊕	6
Inserti a croce Pozidriv®	PZ 1-1-2-2-2-3-3	⊕	7
Inserti esagono maschio	2-3-3-4-4-5-5-6-6	⊙	9
Inserti TORX®	TX 10-10-15-15-20-20-25-25-30-30	⊗	10
Inserti TORX® Tamper Resistant	STX 10-15-15-20-20-25-25-30-30-40	⊗	10
Portainseri magnetico			1



Kg 0,9 Kg L. 215
H. 45
P. 150

692 J100
Cod. U06920043

1/4 **100**
PEZZI

Assortimento di inserti con impronte speciali

~~€ 54,50~~ **€ 40,00**

DESCRIZIONE	MISURA		PZ.
Inserti a intaglio	3-4-4,5-5-5,5-6-6,5-7-8	⊖	9
Inserti a croce	PH 00-0-1-1-2-2-3-4 - PZ 1-2-2-3-4	⊕ ⊕	13
Inserti esagono maschio	1,5-2-2,5-3-4-5-5,5-6-7-8 mm 1/16-5/64-3/32-7/64-1/8-9/64-5/32-3/16-7/32-1/4"	⊙	20
Inserti TORX®	T 8-9-10-15-20-25-27-30-40-45	⊗	10
Inserti TORX® Tamper Resistant	STX 8-10-15-20-25-27-30-40-45	⊗	9
Inserti Tri-Wing	1-2-3-4	⊕	4
Inserti Spanner	4-6-8-10-12	⊕	5
Inserti Torq-set	6-8-10	⊕	3
Inserti quadrati	0-1-2-2-3	⊖	5
Inserti Clutch	1/8-5/32-3/16-1/4-5/16	⊖	5
Inserti XZN	M5-M6-M8	⊗	3
Inserti esagono maschio con foro	2-2,5-3-4-5-6 mm - 5/64-3/32-7/64-1/8-9/64-5/32"	⊙	12
Portainseri magnetici	1/4x60mm		2





Sistema di fissaggio resistente

CHIAVI A T STANDARD

 **280 T**

Disponibile in 14 misure (2÷14 mm)

 **280 TTX**

Disponibile in 15 misure (T6÷T60)

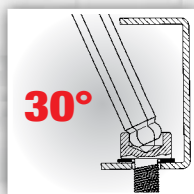

30°



Sistema di fissaggio resistente

CHIAVI A T CON TESTA SFERICA

 **280 TTS**

Disponibile in 6 misure (2,5÷8 mm)

 **280 TSTX**

Disponibile in 4 misure (T15÷T30)



Traversino scorrevole permette di operare anche con scarsa accessibilità. Fermo a due posizioni

CHIAVI A T CON TRAVERSINO SCORREVOLE

 **280 TK**

Disponibile in 6 misure (2,5÷8 mm)

SICUREZZA GARANTITA

Le estremità della chiave sono testate in base alla coppia di serraggio della vite corrispondente. Entro questi valori di coppia, la chiave rientra sempre nel campo elastico senza rischio di deformazione.

La lega d'acciaio con cui sono prodotte le chiavi USAG, garantisce l'inizio della deformazione plastica ad un valore di torsione il 30% superiore a quello prescritto dalla norma.



CHIAVE USAG



ALTRE CHIAVI



Trattamenti di aumento della durezza dell'acciaio, impiegati da altri produttori, possono dare coppie elastiche maggiori, ma con il rischio di pericolose rotture di schianto.



280 T/SE7

Cod. U02800903



7

PEZZI

Serie di 7 chiavi a T con maschio esagonale

- 280 T/2-2,5-3-4-5-6-8 mm
- Per viti con esagono incassato
- Acciaio speciale altamente legato al Silicio Cromo Vanadio
- Esecuzione cromata con estremità brunate per garantire la precisione dimensionale ed il perfetto accompagnamento della vite

~~€ 99,00~~

€ 69,50



280 TTS/SE6

Cod. U02800760



6

PEZZI

Serie di 6 chiavi a T maschio esagonali con testa sferica

- 280 TTS/2,5-3-4-5-6-8 mm
- Per viti con esagono incassato
- Acciaio speciale altamente legato al Silicio Cromo Vanadio
- Esecuzione cromata con estremità brunate
- Modello che permette di operare con inclinazioni fino a 30° rispetto all'asse della vite
- Massima accessibilità con la testa sferica

~~€ 88,00~~

€ 61,50



280 TK/SE6

Cod. U02800020



6

PEZZI

Serie di 6 chiavi a T maschio esagonale con traversino scorrevole

- 280 TK/2,5-3-4-5-6-8 mm
- Per viti con esagono incassato
- Traversino scorrevole che permette di avere maggiore accessibilità rispetto alla chiave standard
- Fermo di sicurezza che impedisce l'estrazione del traversino
- Acciaio speciale altamente legato al Silicio Cromo Vanadio
- Esecuzione cromata con estremità brunate per il gambo
- Esecuzione interamente brunita per il traversino
- Estremità dimensionate per il perfetto accoppiamento con la vite

~~€ 89,00~~

€ 58,50



280 LTS/S9

Cod. U02800084



9

PEZZI

**Serie di 9 chiavi maschio esagonale
lunghe testa sferica**

- 280 LTS/1,5-2-2,5-3-4-5-6-8-10 mm

~~€ 28,50~~

€ 18,00



Estrazione della singola chiave
senza muovere le altre



Estrazione della singola chiave
senza muovere le altre



280 LTSTX/S8

Cod. U02800078



8

PEZZI

**Serie di 8 chiavi maschio lunghe testa
sferica TORX®**

- 280 LTSTX/T10-T15-T20-T25-T27-T30-T40-T45

~~€ 51,50~~

€ 36,00

NEW



232 mm

**MODELLO EXTRA LUNGO
+30% RISPETTO ALLE 280 LTS**

280 XLTS/S9

Cod. U02800184



9

PEZZI

**Serie di 9 chiavi maschio esagonale
extra-lunghe a testa sferica**

- 280 XLTS/1,5-2-2,5-3-4-5-6-8-10 mm

~~€ 32,10~~

€ 22,50



Estrazione della singola chiave
senza muovere le altre



280 S9

Cod. U02800287



9
PEZZI

Serie di 9 chiavi maschio esagonale

- 280/1,5-2-2,5-3-4-5-6-8-10 mm

~~€ 15,40~~

€ 10,80



Estrazione della singola chiave senza muovere le altre

280 TX/S8C

Cod. U02800576



8
PEZZI

Serie di 8 chiavi maschio TORX®

- 280 TX/T10-T15-T20-T25-T27-T30-T40-T45

~~€ 35,70~~

€ 25,00



Estrazione della singola chiave senza muovere le altre

280 STX/S8C

Cod. U02800577



8
PEZZI

Serie di 8 chiavi maschio TORX®

Tamper Resistant

- 280 STX/T10-T15-T20-T25-T27-T30-T40-T45

~~€ 53,57~~

€ 37,50



Estrazione della singola chiave senza muovere le altre

NEW



280 L/S9

Cod. U02800057



9
PEZZI

Serie di 9 chiavi maschio esagonale lunghe

- 280 L/1,5-2-2,5-3-4-5-6-8-10 mm

~~€ 20,30~~

€ 14,20



Estrazione della singola chiave senza muovere le altre

NEW



TESTA SNODATA



285 KF/DS8

Cod. U02856158

8
PEZZI

Serie di 8 chiavi combinate a cricchetto snodate

• 285 KF/8-10-11-12-13-14-17-19 mm

~~€ 160,50~~

€ 112,00



ANELLO DI TENUTA IN
ACCIAIO ARMONICO



285 KA/DS8

Cod. U02856058

8
PEZZI

Serie di 8 chiavi a cricchetto

• 285 KA/8-10-11-12-13-14-17-19 mm

~~€ 137,00~~

€ 90,00

NEW



CAMBIO DEL SENSO
DI ROTAZIONE



285 KB/SR8

Cod. U02856339

8
PEZZI

Serie di 8 chiavi combinate a cricchetto piatte

• 285 KB/8-10-12-13-14-15-17-19 mm

~~€ 106,80~~

€ 75,00



285 SE26

Cod. U02850861

26
PEZZI

Serie di 26 chiavi combinate

- 285/6-7-8-9-10-11-12-13-14-15-16-17-18-19-20-21-22-23-24-25-26-27-28-29-30-32 mm

~~€ 302,00~~

€ 211,00

NEW



285 DS8

Cod. U02850863

8
PEZZI

Serie di 8 chiavi combinate

- 285/8-10-11-12-13-14-17-19 mm
- Fornita con supporto in plastica

~~€ 69,52~~

€ 45,00

NEW



285 DS12

Cod. U02850864

12
PEZZI

Serie di 12 chiavi combinate

- 285/7-8-10-11-12-13-14-15-16-17-18-19 mm
- Fornita con supporto in plastica

~~€ 103,32~~

€ 72,50



276 CE/SE5

Cod. U02760483



5
PEZZI

Serie di 5 chiavi a T snodate

- 276 CE/8-10-13-17-19 mm

~~€ 149,00~~

€ 110,00



276 CE/SE8

Cod. U02760484



8
PEZZI

Serie di 8 chiavi a T snodate

- 276 CE/7-8-10-12-13-14-17-19 mm

~~€ 225,00~~

€ 158,00

NEW



1/2"

273 1/2 Q NTX/S9

Cod. U02730207



9

PEZZI

Chiave a T snodata con 9 chiavi a bussola TORX® maschio

- 233 1/2 NTX T20-T25-T27-T30-T40-T45-T50-T55-T60
- 273 1/2 Q

~~€ 165,50~~

€ 116,00

NEW



1/2"

273 1/2 Q NTX/S7

Cod. U02730206



7

PEZZI

Chiave a T snodata con 7 chiavi a bussola TORX® femmina

- 235 1/2 NTX E10-E12-E14-E16-E18-E20-E24
- 273 1/2 Q

~~€ 93,22~~

€ 65,50

NEW



1/2"

273 1/2 Q/SE9

Cod. U02730205



9

PEZZI

Chiave a T snodata con 8 bussole esagonali

- 235 1/2 EN 8-10-11-12-13-14-17-19 mm
- 273 1/2 Q

~~€ 87,50~~

€ 61,00



Pollici



280 LTSP/S8

Cod. U02800090



8
PEZZI

Serie di 8 chiavi maschio esagonale lunghe testa sferica in pollici

- 280 LTSP 3/32-1/8-5/32-3/16-7/32-1/4-5/16-3/8"

~~€ 28,60~~

€ 20,00



Estrazione della singola chiave senza muovere le altre



Pollici

252 NP/SE7

Cod. U02520872

7
PEZZI

Serie di 7 chiavi a forchetta doppie in pollici

- 252 NP 1/4x5/16-3/8x7/16-1/2x9/16-5/8x11/16-3/4x7/8-15/16x1-11/16x11/8"

~~€ 69,50~~

€ 48,50



Pollici

606 1/4 APOL

Cod. U06060104



18
PEZZI

Assortimento in cassetta di ABS con bussole esagonali in pollici

- Cassetta in ABS ad alta resistenza con sistema di chiusura rapida

~~€ 102,00~~

€ 71,50

DESCRIZIONE	ART./MISURA	PZ.
Chiavi a bussola con bocca esagonale	235 1/4 EPN 1/8-5/32-3/16-7/32-1/4-9/32-5/16-11/32-3/8-7/16-1/2-9/16"	12
Prolunghe	236 1/4 50-100	2
Cricchetto reversibile certificato IP51	237 A 1/4	1
Leva a T con attacco scorrevole	240 1/4	1
Snodo cardanco	241 1/4	1
Portabussole con impugnatura	243 1/4	1



1 Kg



L. 210
H. 60
P. 130



Pollici

280 P/S8

Cod. U02800288



8
PEZZI

Serie di 8 chiavi maschio esagonale in pollici

- 280 P 3/32-1/8-5/32-3/16-7/32-1/4-5/16-3/8"

~~€ 17,00~~

€ 12,60

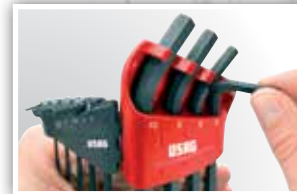

Estrazione della singola chiave senza muovere le altre



Pollici

285 P/SE5

Cod. U02850856

5
PEZZI

Serie di 5 chiavi combinate in pollici

- 285 P 1/4-3/8-7/16-1/2-9/16"

~~€ 40,32~~

€ 28,00



Pollici

606 1/2 APOL

Cod. U06060306



15
PEZZI

Assortimento in cassetta di ABS con bussole poligonali in pollici

- Cassetta in ABS ad alta resistenza con sistema di chiusura rapida

~~€ 181,00~~

€ 127,00



DESCRIZIONE	ART./MISURA	PZ.
Chiavi a bussola con bocca esagonale	235 1/2 EPN 3/8-7/16-1/2-9/16-5/8-3/4-13/16-7/8-11/16-19/32-21/32"	11
Prolunghe	236 1/2 125-250	2
Cricchetto reversibile certificato IP51	237 A 1/2	1
Snodo cardanco	241 1/2	1

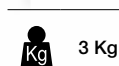

L. 330
H. 60
P. 215

SET INSERTI AVVITATURA CON CRICCHETTO



606 1/4" SK
Cod. U06060012

31
PEZZI

Assortimento inserti con cricchetto reversibile

~~€ 61,00~~

€ 43,00



Inserto portabussole



DESCRIZIONE	PZ.	ART./MISURA
Cricchetto reversibile	1	237 1/4" SFK
Inserti ad intaglio	2	660 0,5x4-1x5,5
Inserti esagonali	9	660 E 1,5-2-2,5-3-4-5-6-7-8
Inserti a croce PHILLIPS®	3	660 PH 1-2-3
Inserti a croce POZIDRIV® - POZIDRIV®	3	660 PZ 1-2-3
Raccordo portainseriti	1	660 Q 1/4"
Inserti TORX® Tamper Resistant	7	660 STX T10-T15-T20-T25-T27-T30-T40
Inserti TORX®	4	660 TX T6-T7-T8-T9
Prolunga magnetica	1	672 1/4" MG 100

1 FUNZIONE CRICCHETTO
Massima accessibilità grazie alla testa compatta ed allo snodo regolabile



60



2 FUNZIONE CHIAVE A T
La prolunga diventa un traversino e puoi usare il cricchetto come una chiave a T portainseri



SET BUSSOLE RIBASSATE CON CRICCHETTO

○ 5,5-6-7-8-9-10-11-12-13-14 mm

610 1/4" EFK

Cod. U06100001

11
PEZZI

Assortimento bussole ribassate
con cricchetto reversibile

~~€ 80,00~~

€ 53,00



BUSSOLE ESAGONALI RIBASSATE
Garantiscono il doppio dell'accessibilità
rispetto all'utilizzo di un cricchetto standard.

180°



-50%





CASSETTE 609 TOP DI GAMMA

- Casette compatte in bimateriale
- Alloggiamenti bussole con indicazione della misura



Chiusa, la cassetta da 1/2" ha le dimensioni di un modulo per carrelli



CASSETTE 606-608 LA GAMMA COMPLETA

- Casette in ABS ad alta resistenza
- Interno in plastica



I moduli contenuti nelle valigette sono estraibili e posizionabili nei cassetti dei carrelli



CASSETTE 601 QUALITÀ E CONVENIENZA

- Cassetta in plastica preformata
- Clip di aggancio in metallo



Valigette modulari con i cassetti dei carrelli

Just **USAG**

COMPATTA
Sta in tasca!



609 1/4 EB

Cod. U06090002



38
PEZZI

Assortimento con bussole esagonali ed inserti per avvitatura

- Cassetta compatta in bimatrimiale con rivestimento soft-touch

~~€ 171,00~~

€ 120,00

DESCRIZIONE	ART./MISURA	PZ.	DESCRIZIONE	ART./MISURA	PZ.
Bussole esagonali	235 1/4" EN 5,5-6-7-8-9-10-11-12-13-14 mm	10	Inserti PH	660 PH 1-2-3	3
Prolunghe	236 1/4" 50-100	2	Inserti PZ	660 PZ 1-2-3	3
Cricchetto reversibile	237 B 1/4"	1	Inserti esagonali	660 E 2-3-4-5-6	5
Snodo cardanico	241 1/4"	1	Inserti Torx®	660 STX T10-T15-T20-T25-T27-T30-T40	7
Impugnatura porta-bussola	243 1/4" C	1	Tamper Resistant®	660 Q 1/4"	1
Inserti ad intaglio	660 0,6x4,5-1x5,5-1,2x6,5	3	Inserto porta-bussola	660 Q 1/4"	1
			Bussola porta-inserti	684 1/4"-1/4"	1



1/4"



0,9 Kg



L. 155
H. 50
P. 95



NEW

608 1/4 EA

Cod. U06080101



37
PEZZI

Assortimento in cassetta di ABS con bussole esagonali

- Cassetta in ABS ad alta resistenza con sistema di chiusura rapida
- Interno in spugna bicolore

~~€ 170,00~~

€ 99,00

DESCRIZIONE	ART./MISURA	PZ.
Chiavi a bussola con bocca esagonale	235 1/4 EN 5,5-6-7-8-9-10-11-12-13-14	10
Prolunghe	236 1/4 50-100	2
Cricchetto reversibile certificato IP51	237 A 1/4	1
Snodo cardanico	241 1/4	1
Portabussole con impugnatura	243 1/4	1
Inserti per viti con intaglio	660/ 0,6x4,5-0,8x5,5-1x5,5	3
Inserti per viti con esagono incassato	660 E/ 2,5-3-4-5-6	5
Inserti per viti con impronta a croce PHILLIPS®	660 PH/1-2-3	3
Inserti per viti con impronta a croce POZIDRIV® - SUPADRIV®	660 PZ/1-2-3	3
Inserti per viti con impronta TORX® Tamper Resistant	660 STX/ T10-T15-T20-T25-T27-T30-T40	7
Bussole portainseri	684/1/4-5/16	1



1/4"



0,8 Kg



L. 210
H. 60
P. 130



601 1/4 J34

Cod. U06010001

Just **USAG**



34
PEZZI

Assortimento in cassetta modulare con bussole esagonali ed inserti per avvitatura

~~€ 70,00~~

€ 46,00

DESCRIZIONE	MISURA	PZ.
Chiavi a bussola 1/4"	4-4,5-5-5,5-6-7-8-9-10-11-12-13-14	13
Cricchetto reversibile 1/4"		1
Snodo cardanico 1/4"		1
Prolunghe 1/4"	55-100	2
Inserti a intaglio	4-5,5-6	3
Inserti a croce Pozidriv®	1-2-3	3
Inserti esagono maschio	4-5-6	3
Inserti TORX®	10-15-20-25-20-40	6
Impugnatura maschio/femmina		1
Raccordo portainseri 1/4"		1

1/4"



1 Kg



L. 190
H. 58
P. 144



1/2"

Kg 3,7 Kg **mm** L. 335
H. 55
P. 180

609 1/2 EB

Cod. U06090022



21
PEZZI

Assortimento con bussole esagonali

- Cassetta in bimatrimiale con rivestimento soft-touch

~~€ 220,00~~

€ 155,00

DESCRIZIONE	ART./MISURA	PZ.
Bussole esagonali	235 1/2" EN 8-10-11-12-13-14-15-16-17-18-19-21-22-24-27-30-32	17
Prolunghe	236 1/2" 125-250	2
Cricchetto reversibile	237 B 1/2"	1
Snodo cardanico	241 1/2"	1

606 1/2 EA

Cod. U06060302



23
PEZZI

Assortimento in cassetta di ABS con bussole esagonali

- Cassetta in ABS ad alta resistenza con sistema di chiusura rapida

~~€ 205,00~~

€ 125,00

DESCRIZIONE	ART./MISURA	PZ.
Chiavi a bussola con bocca esagonale	235 1/2 EN 8-9-10-11-12-13-14-15-16-17-18-19-21-22-23-24-27-30-32	19
Prolunghe	236 1/2 125-250	2
Snodo cardanico	241 1/2	1
Cricchetto reversibile certificato IP51	237 A 1/2	1



1/2"

Kg 3 Kg **mm** L. 330
H. 60
P. 215

601 1/2 J22

Cod. U06010003



22
PEZZI

Assortimento in cassetta modulare con bussole esagonali

~~€ 103,00~~

€ 67,00

DESCRIZIONE	MISURA	PZ.
Bussole esagonali 1/2"	8-10-11-12-13-14-15-16-17-18-19-21-22-24-27-30-32	17
Cricchetto 1/2"		1
Prolunghe 1/2"	130-250	2
Snodo cardanico 1/2"		1
Leva a T 1/2"		1

1/2"

Kg 4 Kg **mm** L. 372
H. 80
P. 186

Just **USAG**

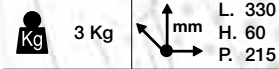
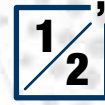

606 1/4-1/2 EA

Cod. U06060312



30
PEZZI

Assortimento in cassetta di ABS con bussole esagonali

- Cassetta in ABS ad alta resistenza con sistema di chiusura rapida

~~€ 240,00~~

€ 168,00

DESCRIZIONE	ART./MISURA	PZ.
Chiavi a bussola con bocca esagonale	235 1/2 EN 10-11-12-13-14-15-16-17-18-19-21-22-24-27	14
Chiavi a bussola con bocca esagonale	235 1/4 EN 5,5-6-7-8-9-10-11-12-13	9
Prolunghe	236 1/2 125	1
Prolunghe	236 1/4 100	1
Cricchetto reversibile certificato IP51	237 A 1/2	1
Cricchetto reversibile certificato IP51	237 A 1/4	1
Snodo cardanico	241 1/2	1
Snodo cardanico	241 1/4	1
Portabussole con impugnatura	243 1/4	1

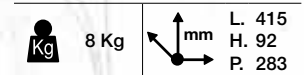

Just **USAG**

601 1/4-1/2 J100

Cod. U06010011



100
PEZZI

Assortimento in cassetta modulare con bussole esagonali ed inserti per avvitatura

~~€ 172,00~~

€ 119,00

DESCRIZIONE	MISURA	PZ.
Chiavi a bussola 1/4" con bocca esagonale	4-4,5-5,5-6-7-8-9-10-11-12-13-14 mm	12
Chiavi a bussola 1/4" lunghe con bocca esagonale	6-8-10-11-12-13-14 mm	7
Chiavi a bussola 1/4" con bocca TORX®	E6-E8-E10	3
Chiavi a bussola 1/4" con inserto a croce PH	1-2	2
Chiavi a bussola 1/4" con inserto a croce PZ	1-2	2
Chiavi a bussola 1/4" con inserto ad intaglio	0,6x4-1,2x7	2
Chiavi a bussola 1/4" con inserto esagonale maschio	3-4-5-6	4
Chiavi a bussola 1/4" con inserto TORX®	T8-T10-T15-T20-T25-T27-T30	7
Prolunghe 1/4"	50-100 mm	2
Snodo cardanico 1/4"		1
Leva a T 1/4"		1
Impugnatura porta-bussole 1/4"		1
Cricchetto reversibile 1/4"		1
Chiavi a bussola 1/2" con bocca esagonale	10-11-12-13-14-15-16-17-18-19-20-21-22-24-27-30-32 mm	17
Chiavi a bussola 1/2" lunghe con bocca esagonale	13-14-15-17-19-22 mm	6
Chiavi a bussola 1/2" con bocca TORX®	E12-E14-E16-E18-E20-E24	6
Chiavi a bussola 1/2" per candele	16-21 mm	2
Prolunghe 1/2"	130-250 mm	2
Snodo cardanico 1/2"		1
Cricchetto reversibile 1/2"		1
Riduttore	1/2"-3/8"	1
Chiave a bussola portainseri	1/2"-5/16"	1
Inserti 5/16" ad intaglio	8-12	2
Inserti 5/16" a croce PH	3-4	2
Inserti 5/16" a croce PZ	3-4	2
Inserti 5/16" TORX®	T40-T45-T50-T55	4
Inserti 5/16" esagonali maschio	8-10-12-14 mm	4
Inserti 5/16" XZN	6-8-10-12	4



3/8"

2 Kg L. 280
H. 50
P. 150

609 3/8 EB

Cod. U06090012



18
PEZZI

Assortimento con bussole esagonali

- Cassetta in bimatereale con rivestimento soft-touch

~~€ 177,00~~

€ 124,00

DESCRIZIONE	ART./MISURA	PZ.
Bussole esagonali	235 3/8" 8-9-10-11-12-13-14-15-16 17-18-19-21-22 mm	14
Prolunghe	236 3/8" 125-250	2
Cricchetto reversibile	237 B 3/8"	1
Snodo cardanico	241 3/8"	1



3/8"

1,5 Kg L. 435
H. 70
P. 270

606 3/8 EA

Cod. U06060202



21
PEZZI

Assortimento in cassetta di ABS con bussole esagonali

- Cassetta in ABS ad alta resistenza con sistema di chiusura rapida

~~€ 173,00~~

€ 102,00

DESCRIZIONE	ART./MISURA	PZ.
Chiavi a bussola con bocca esagonale	235 3/8 E 6-7-8-9-10-11-12-13-14-15-16-17-18-19-21-22	16
Prolunghe	236 3/8 125-250	2
Cricchetto reversibile certificato IP51	237 A 3/8	1
Leva a T con attacco quadro scorrevole	240 3/8 N	1
Snodo cardanico	241 3/8	1



NEW



3/8"

2 Kg L. 330
H. 60
P. 215

604 3/8 EA

Cod. U06040202



18
PEZZI

Assortimento in cassetta di ABS con bussole esagonali

- Cassetta in ABS ad alta resistenza con sistema di chiusura rapida

~~€ 155,00~~

€ 109,00

DESCRIZIONE	ART./MISURA	PZ.
Chiavi a bussola con bocca esagonale	235 3/8 E 8-9-10-11-12-13-14-15-16-17-18-19-21-22	14
Prolunghe	236 3/8 125-250	2
Cricchetto reversibile certificato IP51	237 A 3/8	1
Snodo cardanico	241 3/8	1



607 1/2 EA

Cod. U06070302



30
PEZZI

Assortimento in cassetta di ABS con bussole esagonali

~~€ 283,00~~

€ 184,00

607 1/2 A

Cod. U06070301



30
PEZZI

Assortimento in cassetta di ABS con bussole poligonali

- Cassetta in ABS ad alta resistenza con sistema di chiusura rapida

~~€ 282,00~~

€ 184,00



1 1/2"



4,5 Kg



L. 435
H. 70
P. 270

DESCRIZIONE	ART./MISURA	PZ.
Chiavi a bussola con bocca esagonale (Poligonale)	235 1/2 E(N) 8-9-10-11-12-13-14-15-16-17-18-19-20-21-22-23-24-26-27-28-29-30-32-34	24
Prolunghe	236 1/2 125-250	2
Manovella con impugnatura girevole	239 1/2 N	1
Leva a T con attacco quadro scorrevole	240 1/2 N	1
Snodo cardanico	241 1/2	1
Cricchetto reversibile certificato IP51	237 A 1/2	1



605 3/4 EB

Cod. U06050212



18
PEZZI

Assortimento con bussole esagonali

~~€ 531,00~~

€ 372,00

605 3/4 B

Cod. U06050211



18
PEZZI

Assortimento con bussole esagonali o poligonali

- Cassetta in ABS
- Clip di aggancio in metallo

~~€ 531,00~~

€ 372,00

120



3 1/4"



15 Kg



L. 415
H. 100
P. 565

DESCRIZIONE	ART./MISURA	PZ.
Bussole esagonali (poligonali)	235 3/4 E(N) 19-21-22-24-27-30-32-34-36-41-46-50-55	13
Prolunghe	236 3/4" 200-400	2
Leva a T con attacco Quadro scorrevole	240 3/4 N	1
Snodo cardanico	241 3/4	1
Cricchetto reversibile	237 B 3/4	1

VALIGIA PER MANUTENZIONE

Just **USAG**



11 Kg



L. 460
H. 155
P. 370

002 JM
Cod. U00020001

181
PEZZI

Valigia con assortimento per manutenzione

- Valigia con struttura in profilato di Alluminio e rinforzi in metallo
- Doppia cerniera di chiusura in metallo con serratura
- 3 pannelli portautensili interni con elastici di tenuta
- Base con interno in mousse bicolore sagomata

~~€ 543,00~~

€ 369,00



**SAGOME
DEGLI UTENSILI**
sui pannelli interni.





**MOUSSE
BICOLORE**
con indicazione
della misura.



DESCRIZIONE	MISURA	PZ.
Chiavi a bussola 1/2" con bocca esagonale	10-11-12-13-14-15-16-17-18-19-21-22-24-27-30-32 mm	16
Chiavi a bussola 1/4" con bocca esagonale	4-4,5-5-5,5-6-7-8-9-10-11-12-13-14 mm	13
Prolunghe 1/2"	130-250 mm	2
Prolunghe 1/4"	55-100 mm	2
Cricchetto reversibile 1/2"		1
Cricchetto reversibile 1/4"		1
Impugnatura porta bussole 1/4"		1
Snodo cardanico 1/2"		1
Snodo cardanico 1/4"		1
Bussola portainseri	1/4-1/4"	1
Chiavi combinate	8-9-10-11-12-13-14-15-16-17-18-19 mm	12
Chiave a rullino	250 mm	1
Giraviti ad intaglio	0,4x2,5-0,6x3,5-0,8x4-1x5,5-1,2x6,5-1,6x8	6
Giraviti a croce PH	1-2	2
Giraviti a croce PZ	1-2	2
Chiavi maschio esagonali	1,5-2-2,5-3-4-5-6-8-10 mm	9
Pinza universale	180 mm	1
Pinza regolabile	240 mm	1
Pinza a becchi mezzotondi	160 mm	1

DESCRIZIONE	MISURA	PZ.
Tronchese a taglio diagonale	160 mm	1
Giravite cercafase		1
Forbice da elettricista		1
Cutter multiuso		1
Flessometro	5 m	1
Mini seghetto		1
Martello da meccanico	300 gr	1
Inseri ad intaglio	3-4-4,5-5-5,5-6-6,5-7-8	9
Inseri a croce PH	00-0-1(x2)-2(x2)-3-4	8
Inseri a croce PZ	1-2(x2)-3-4	5
Inseri esagonali maschio	1,5-2-2,5-3-4-5-5,5-6-7-8 mm	10
Inseri esagonali maschio	1/16-5/64-3/32-7/64-1/8-9/64-5/32-3/16-7/32-1/4	10
Inseri Torx	T8-T9-T10-T15-T20-T25-T27-T30-T40-T45	10
Inseri Torx Tamper Resistant	T8-T10-T15-T20-T25-T27-T30-T35-T45	9
Inseri Tri-Wing	1-2-3-4	4
Inseri Spanner	4-6-8-10-12	5
Inseri Torq-set	6/8/10	3
Inseri quadrati	0-1-2(x2)-3	5
Inseri Clutch	1/8-5/32-3/16-1/4-5/16	5
Inseri XZN	M5-M6-M8	3
Inseri esagonali maschio con foro	2-2,5-3-4-5-6	6
Inseri esagonali maschio con foro	5/64-3/32-7/64-1/8-9/64-5/32	6
Prolunghe magnetiche	1/4"	2

Just **USAG**

 11 Kg	 L. 460 H. 155 P. 370
---	--

NEW

002 JTM
Cod. U00020005

181
PEZZI

Valigia trolley con assortimento per manutenzione

- Ruote integrate nella struttura
- Valigia con struttura in profilato di Alluminio
- e rinforzi in metallo
- Doppia cerniera di chiusura in metallo con serratura
- 3 pannelli portautensili interni con elastici di tenuta
- Base con interno in mousse bicolore sagomata

~~€ 573,00~~

€ 399,00



**RUOTE INTEGRATE
NELLA STRUTTURA**



DESCRIZIONE	MISURA	PZ.
Chiavi a bussola 1/2" con bocca esagonale	10-11-12-13-14-15-16-17-18-19-21-22-24-27-30-32 mm	16
Chiavi a bussola 1/4" con bocca esagonale	4-4,5-5-5,5-6-7-8-9-10-11-12-13-14 mm	13
Prolunghe 1/2"	130-250 mm	2
Prolunghe 1/4"	55-100 mm	2
Cricchetto reversibile 1/2"		1
Cricchetto reversibile 1/4"		1
Impugnatura porta bussola 1/4"		1
Snodo cardanico 1/2"		1
Snodo cardanico 1/4"		1
Bussola portainseriti	1/4-1/4"	1
Chiavi combinate	8-9-10-11-12-13-14-15-16-17-18-19 mm	12
Chiave a rullino	250 mm	1
Giraviti ad intaglio	0,4x2,5-0,6x3,5-0,8x4-1x5,5-1,2x6,5-1,6x8	6
Giraviti a croce PH	1-2	2
Giraviti a croce PZ	1-2	2
Chiavi maschio esagonali	1,5-2-2,5-3-4-5-6-8-10 mm	9
Pinza universale	180 mm	1
Pinza regolabile	240 mm	1
Pinza a becchi mezzotondi	160 mm	1
Tronchese a taglio diagonale	160 mm	1
Giravite cercafase		1
Forbice da elettricista		1



DESCRIZIONE	MISURA	PZ.
Cutter multiuso		1
Flessometro	5 m	1
Mini seghetto		1
Martello da meccanico	300 gr	1
Inseriti ad intaglio	3-4-4,5-5-5,5-6-6,5-7-8	9
Inseriti a croce PH	00-0-1(x2)-2(x2)-3-4	8
Inseriti a croce PZ	1-2(x2)-3-4	5
Inseriti esagonali maschio	1,5-2-2,5-3-4-5-5,5-6-7-8 mm	10
Inseriti esagonali maschio	1/16-5/64-3/32-7/64-1/8-9/64-5/32-3/16-7/32-1/4	10
Inseriti Torx	T8-T9-T10-T15-T20-T25-T27-T30-T40-T45	10
Inseriti Torx Tamper Resistant	T8-T10-T15-T20-T25-T27-T30-T35-T45	9
Inseriti Tri-Wing	1-2-3-4	4
Inseriti Spanner	4-6-8-10-12	5
Inseriti Torq-set	6/8/10	3
Inseriti quadrati	0-1-2(x2)-3	5
Inseriti Clutch	1/8-5/32-3/16-1/4-5/16	5
Inseriti XZN	M5-M6-M8	3
Inseriti esagonali maschio con foro	2-2,5-3-4-5-6	6
Inseriti esagonali maschio con foro	5/64-3/32-7/64-1/8-9/64-5/32	6
Prolunghe magnetiche	1/4"	2



Cassetti inferiori a estrazione totale montati su guide telescopiche



Pannelli forati e ante predisposti per l'alloggiamento degli utensili (anta doppia solo 502 A2)

 45 Kg  L. 720
H. 1000
P. 280



502 A2

Cod. U05020004

2
Cassetti

Armadio vuoto a 2 cassetti

- Fornito senza ganci e supporti
- Dimensioni aperto: 1380x515x1000 mm
- Dimensioni interne cassetto: 570x210x60 mm

~~€ 926,00~~

€ 648,00



532 C

Cod. U05320007

 Kg 16

Baule portautensili (vuoto)

- Apertura ad arresto a 95°
- Gancio per chiusura a lucchetto
- Struttura in lamiera di acciaio, spessore 1,2 mm

~~€ 134,00~~

€ 94,00



646/5LV

Cod. U06460301

5
SCOMPARTI

 Kg 6,6

Cassetta estensibile LUNGA (vuota)

- Dimensioni interne:
 - vano 537x207x102 mm
 - scomparti 537x103x52 mm

~~€ 56,50~~

€ 39,50



Kg	2,5 Kg	mm	L. 420
			H. 340
			P. 240



Tutta l'attrezzatura a portata di mano

007/1V

Cod. U00070001

MAX
11 kg

Borsa professionale portautensili (vuota)

- Nylon ad altissima resistenza
- Base rigida e resistente all'acqua
- Pratici e comodi vani interni portautensili
- Due tasche frontali portaminuteria
- Pratico maniglione in alluminio
- Ganci interni porta flessometro ed elastici portautensili
- Mantella di chiusura tramite velcro

~~€ 64,50~~

€ 47,50



Kg	3,1 Kg	mm	L. 355
			H. 225
			P. 460



Tasca porta Notebook o documenti

007 SV

Cod. U00070004

MAX
12 kg



CAPACITA'
30L

Zaino professionale portautensili (vuoto)

- Nylon ad altissima resistenza
- Cinturino pettorale regolabile
- Cinghie in vita imbottite
- Base rigida resistente all'acqua
- Vano interno portautensili
- Portadocumenti interno
- La tasca posteriore può contenere Notebook di dimensioni: L 340 mm - H 240 mm

~~€ 78,00~~

€ 57,50



Kg	1,8 Kg	mm	L. 460
			H. 350
			P. 160



Tasche interne portautensili. Apertura frontale per rapido accesso agli utensili

007 RV

Cod. U00070033

MAX
8 kg



Borsa per utensili e PC (vuota)

- Nylon ad altissima resistenza.
- Base rigida rinforzata.
- 14 tasche, 2 cinghie portautensili e 1 gancio porta flessometro.
- Tracolla amovibile per un comfort extra nel trasporto.
- Chiusura tramite fibbie a scatto con sgancio rapido.

~~€ 55,00~~

€ 40,50



Kg	2,1 Kg	mm	L. 486
			H. 236
			P. 266



Sistema di apertura con una sola mano

641 TB

Cod. U06410005

19"

Cassetta portautensili (vuota)

- In materiale plastico ad alta resistenza
- 2 scomparti portaminuteria sul coperchio
- Possibilità di chiusura con lucchetto (non fornito)
- Vassoio interno amovibile

~~€ 27,50~~

€ 19,30

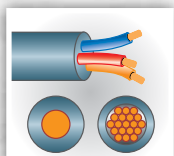

0,02÷10 mm²

146 B

Cod. U01460004

Pinza spellafili automatica piegata a 90°

- Funzioni di taglio e spellatura dei fili elettrici
- Capacità 0,02-10 mm²/AWG 34-80
- Ganasce intercambiabili senza uso di utensili
- Tagliafili integrato nel corpo dell'utensile

~~€ 101,00~~

€ 70,50



0,5÷1 1,5÷2,5 4÷6 mm²

751

Cod. U07510002

Pinza per capicorda preisolati

- Modello a cremagliera per una compressione progressiva e calibrata del capicorda, con riapertura automatica delle ganasce a compressione ultimata
- Impugnature in PVC
- Ganasce in acciaio microfuso
- Corpo in lamiera d'acciaio

~~€ 52,00~~

€ 36,50



0.14÷10 mm²
AWG 26-8

753 KA

Cod. U07530004

Crimpatrice autoregolante per puntalini a sezione quadrata

- Per puntalini isolati e non isolati
- Capacità 0,14-10 mm²/AWG 26-8
- Sistema di ripresa per operazioni multiple consecutive
- Permette di crimpare applicando poca forza sulle impugnature

~~€ 204,00~~

€ 143,00



060 K

Cod. U00600008

Assortimento in cassetta di plastica

- Fornito con saldatore 060/100, ugello di ricambio, cappuccio di protezione, 4 diverse punte e rocchetto stagno 60/40 con antiossidante

~~€ 134,00~~

€ 94,00



CE

CAT III 600V



076 A

Cod. U00760003

MAX
600 V

MAX
10 A

Multimetro Digitale Professionale

- Misura di tensione e corrente AC/DC, frequenza,
- resistenza e capacità
- Prova di continuità e diodi
- Funzione ciclo di lavoro
- Auto calibrazione
- Memorizzazione dati
- Modalità relativa
- Fornito con coppia di puntali

~~€ 150,00~~

€ 105,00

CARATTERISTICHE TECNICHE		CARATTERISTICHE TECNICHE	
Tensione continua DC (mV÷V)	400÷600	Capacità (nF÷µF)	40÷100
Tensione alternata AC (mV÷V)	4÷600	Frequenza kHz	10÷100
Corrente continua DC (µA÷A)	400÷10	Risposta di frequenza Hz	40÷400
Corrente alterata AC (µA÷A)	400÷10	Protezione per sovraccarico DC/AC (V)	600
Resistenza (Ω÷MΩ)	400÷40	Tipo batterie (fornite)	1x9V 6F22



163

Cod. U01630001

Sguainacavi multifunzione

- Per il taglio circolare e longitudinale di
- cavi con rivestimento esterno in PVC
- Sistema a grilletto (-30% di sforzo): forza necessaria 75 N
- Rotella di avanzamento della lama
- Lama di spellatura auto rotante
- Blocco grilletto con lama estratta
- Blocco di sicurezza della lama
- Corpo ergonomico in materiale plastico
- Lama di ricambio inclusa

~~€ 35,00~~

€ 24,50



Ø 4÷28 mm



TAGLIACAVI
fino a 15 mm



IMPUGNATURE BIMATERIALE
con anelli larghi, anche per 2 dita

LAME IN ACCIAIO INOX

MANICI RESISTENTI
oltre 900 N di forza!

SUPPORTO DA CINTURA
fornito di serie

NEW

207 N

Cod. U02070007

Forbice per elettricisti

~~€ 17,50~~

€ 12,90

DIN 6473

200 S

Cod. U02000002

Seghetto

- Modello per lame da 300 mm con possibilità di orientamento della lama a 45° ed a 90°
- Sistema di tensionamento della lama integrato nell'impugnatura
- Anima in acciaio rivestita in materiale plastico antiscivolo ed antiurto
- Fornito con lama al Cobalto

~~€ 29,80~~

€ 21,00

385 mm



367 SE6

Cod. U03670081

6
PEZZI

Serie di 6 cacciaspine

- 367/2x110-3x130-4x145-5x165-6x180-8x200 mm

~~€ 47,30~~

€ 33,00



372 SE6

Cod. U03720181

6
PEZZI

Assortimento in busta di plastica

- 362/125-150 - Scalpelli
- 366/3x125-4x150 - Punzoni
- 364/125 - Ugnetto
- 368/4x125 - Bulino

~~€ 44,70~~

€ 31,50



376

Mazzuole

- Modello a tasselli intercambiabili in materiale plastico
- Corpo in acciaio al Carbonio
- Manico in frassino

CODICE	Ø TASSELLI	LUNGHEZZA (MM)	€	€
U03760001	22	250	10,80	7,60
U03760002	28	275	14,20	9,90
U03760003	35	300	18,10	12,70
U03760004	42	325	24,30	17,00
U03760005	50	350	33,40	23,50
U03760006	60	380	48,40	34,00

960 D

Cod. U09600014

Calibro digitale centesimale

- Campo di misura: 150 mm / 6"
- Risoluzione: 0,01 mm / 0,0005"
- Corpo in acciaio inox
- Conversione mm/pollici
- Altezza caratteri visualizzati: 9 mm
- Misurazione profondità tramite asta tonda (Ø1,5 mm)
- Sistema di bloccaggio cursore tramite vite
- Fornito in cassetta di plastica

~~€ 101,00~~

€ 70,50



DIN 862



Elevata leggibilità



Misurazione di profondità

988 D/S3

Cod. U09880020

HSS

3
PEZZI



Serie di 3 frese a scalino

- 988 D/1-2-3
- In acciaio HSS
- Per forature cilindriche su materiali ferrosi e non ferrosi

~~€ 164,00~~

€ 115,00

ART.	N. SCALINI	Ø MM	Ø CODOLO MM	LUNGHEZZA
988 D1	9	4-5-6-7-8-9-10-11-12	6	65
988 D2	9	4-6-8-10-12-14-16-18-20	8	75
988 D3	14	4-6-8-10-12-14-16-18-20-22-24-26-28-30	10	100

Ø gambo
6mm

988 E/S10

Cod. U09880062

10
PEZZI

Frese rotative in metallo duro

- Serie in cassette di lamiera 10 pezzi:
 - n°8 pezzi (Ø 10 e 12 forme EA-EC-EF-EG)
 - n°2 pezzi (Ø 12 forme ED-EM)
- Per lavorazione su acciai trattati, acciai inox, materiali metallici in genere e plastica

~~€ 417,00~~

€ 292,00

988 G/S12

Cod. U09880100

HSS

12
PEZZI



Serie di 10 seghe a tazza bimetalliche

- Ø 19-22-25-29-35-38-44-51-57-64 mm
- Per la foratura di tutti i tipi di materiale con spessori piccoli
- Dentatura variabile in acciaio HSS
- Intagli laterali per facilitare la fuoriuscita del materiale
- Profondità di taglio max 38 mm

~~€ 168,00~~

€ 118,00

988 LA/S14

Cod. U09880070

HSS

14
PEZZI

Assortimento di punte e maschi

- Assortimento di punte e maschi per fori ciechi e passanti in HSS-G
- Rettificati
- Fornito in cassetta in ABS
- Ø punte: 2,5-3,3-4,2-5,0-6,8-8,5-10,2
- M maschi: 3x0,5-4x0,7-5x0,8-6x1-8x1,25-10x1,5-12x1,75

~~€ 73,50~~

€ 51,50

DIN 338
DIN 371/376





454 SE3

Cod. U04549002P

3
PEZZI

Serie di 3 estrattori a due bracci per esterni

- 454/0-1-2

~~€ 226,00~~

€ 158,00



451 N/S4

Cod. U04510100

4
PEZZI

Estrattore a tre bracci per esterni

- Modello a bracci autoserranti
- Capacità: 7÷140 mm
- Potenza: 3 ton
- Spina di sicurezza
- Vite di manovra con esagono da 18 mm
- Possibilità di utilizzo a due bracci
- Viti di manovra M16x2

~~€ 206,00~~

€ 144,00

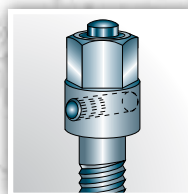

Spina di sicurezza aumenta la sicurezza nell'utilizzo e preserva la qualità dell'attrezzo

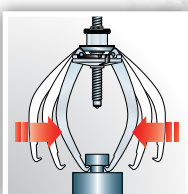

Autoserrante
Autocentrante



458 BK1/S11

Cod. U04580311

11
PEZZI

Serie di 11 estrattori per dadi danneggiati

- Fornita con guida in lamiera
- Quadro di manovra 3/8 (8-10-11-12-13-14 mm)
- Quadro di manovra 1/2 (15-16-17-18-19 mm)

~~€ 168,00~~

€ 118,00



**SOLO PER USO
MANUALE.**

Non utilizzare con utensili pneumatici o elettrici

**Ø 5÷20
mm**



459

Cod. U04590001

Estrattore ad eccentrico per viti prigioniere

- Modello con quadro femmina di manovra 1/2" per l'avvitamento o l'estrazione di viti prigioniere
- Acciaio speciale altamente legato al Cromo Vanadio
- Esecuzione cromata e brunita

~~€ 50,50~~

€ 35,50



RAME



314 A

Cod. U03140010

Ø
3-16
mm

Ø
1/8-5/8
"

Tagliatubi per tubi in rame e lega leggera

- Modello compatto a limitato raggio di rotazione per operare in spazi ristretti.
- Rulli di scorrimento scanalati per il taglio di tubi bordati.
- Spessore massimo: 2 mm.
- Corpo in lega leggera.
- Esecuzione verniciata.

~~€ 25,00~~

€ 17,50



RAME

Inserto in acciaio filettato per uno scorrimento rapido



314 C

Cod. U03140032

Ø
3-30
mm

Ø
1/8-1 1/8
"

Tagliatubi per tubi in rame e lega leggera

- Rulli di scorrimento scanalati per il taglio di tubi bordati
- Sostituzione rapida della rotella senza bisogno di utensili
- Spessore massimo tubo: 2 mm

~~€ 30,50~~

€ 21,50



RAME



314 DA

Cod. U03140033

Ø
3-35
mm

Ø
1/8-1 3/8
"

Tagliatubi per tubi in rame e lega leggera

- Modello ad avanzamento telescopico e ingombro costante
- 4 rulli di scorrimento scanalati per il taglio di tubi bordati
- Sostituzione rapida della rotella senza bisogno di utensili
- Pomello ergonomico
- Corpo in lega leggera
- Esecuzione verniciata
- Spessore massimo tubo: 2 mm
- Lama svasatubi incorporata
- Fornito con 2 rotelle, una montata e una nel pomello

~~€ 60,00~~

€ 42,00

Sistema di chiusura
con una sola mano



PLASTICA



317 AM

Cod. U03170001

Ø
22
mm

Ø
7/8
"

Tagliatubi per tubi in PEX e plastica

- Lama con geometria speciale e rivestimento in PTFE
- Ritorno automatico della lama
- Sistema di chiusura con una sola mano
- Dimensioni: 169x50x19 mm

~~€ 35,60~~

€ 25,00



Ritorno della lama
con una sola mano.



PLASTICA



317 BM

Cod. U03170010

Ø
42
mm

Ø
1 5/8
"

Tagliatubi per tubi e profilati in plastica

- Per tubi in PVC, multistrato e PEX
- Azione di taglio progressiva con il minimo sforzo
- Sostituzione rapida della lama senza bisogno di utensili
- Lama completamente integrata nel corpo del prodotto
- Lama in acciaio Inox con geometria speciale e rivestimento in PTFE
- Ritorno della lama con una sola mano
- Impugnatura ergonomica bimateriale
- Dimensioni: 242x107x25 mm

~~€ 74,50~~

€ 52,00



PLASTICA



317 EM

Cod. U03170005

Ø
26
mm

Ø
1
"

Tagliatubi per tubi in PEX

- Lama con geometria speciale e rivestimento in PTFE
- 4 rulli con cuscinetti integrati nella ganascia per facilitare la rotazione del tubo durante il taglio
- Sistema a 4 lame integrato nell'impugnatura per il taglio delle canaline in tubo corrugato (diametro 18-35 mm) senza danneggiare il tubo interno
- Ritorno automatico della lama
- Sistema di chiusura con una sola mano
- Impugnatura ergonomica bimateriale
- Dimensioni: 189x65,5x28 mm

~~€ 86,50~~

€ 60,50

TAGLIO CANALINE

Sistema integrato nell'impugnatura per il taglio delle canaline in tubo corrugato (impianti sanitari)

ISO 6789



1/4"

3/8"

1/2"

810 N

Precisione
±4%

Chiave dinamometrica con cricchetto reversibile

- Modello a coppia regolabile per serraggi destrorsi
- Riarmo automatico al rilascio dopo il disinnesto
- Fornita con certificato di collaudo

ARTICOLO	CODICE	CAPACITÀ	□	L (MM)	RISOL.	€	€
810 N 5	U08104000	1 ÷ 5	1/4"	197	0,05	188,00	€ 122,00
810 N 25	U08104001	5 ÷ 25	1/4"	290	0,05	194,00	€ 122,00
810 N 50	U08104002	10 ÷ 50	3/8"	350	0,25	194,00	€ 122,00
810 N 100	U08104003	20 ÷ 100	1/2"	410	0,25	194,00	€ 122,00
810 N 200	U08104005	40 ÷ 200	1/2"	475	0,5	196,00	€ 122,00
810 N 340	U08104006	68 ÷ 340	1/2"	630	1	225,00	€ 144,00

812 N

Precisione
±4%

Chiavi dinamometriche con cricchetto reversibile

- **812 N 600:** Modello a coppia regolabile per serraggi destrorsi e sinistrorsi con rotazione del cricchetto di 180°
- **812 N 1000:** Modello a coppia regolabile per serraggi destrorsi
- Precisione ±4% del valore di coppia impostato
- Scala di lettura in Nm
- Segnale sensitivo e sonoro al raggiungimento della coppia impostata
- Riarmo automatico al rilascio dopo il disinnesto
- Blocco di sicurezza dopo la regolazione della coppia
- Fornita in cassetta di lamiera completa di certificato di collaudo
- Cricchetto con attacco quadro 3/4"

3/4"

ARTICOLO	CODICE	CAPACITÀ	□	€	€
812 N 600	U08120006	120 ÷ 600	3/4"	883,00	€ 618,00
812 N 1000	U08120010	200 ÷ 1000	3/4"	1.105,00	€ 774,00



1/2"



ISO 6789



810 F

Precisione
±4%

Chiave dinamometrica con cricchetto reversibile a testa snodata

- Testa snodata per agevolare l'utilizzo in spazi ridotti o profondi
- Angolo di inclinazione fino a 20°
- Scala di lettura in Nm
- Modello a coppia regolabile per serraggi destrorsi
- Riarmo automatico al rilascio dopo il disinnesto
- Fornita con certificato di collaudo



IMPORTANTE

Quando la chiave è utilizzata inclinata a +/- 20° la coppia di serraggio deve essere impostata con un incremento del +5%.

Esempio:

Coppia necessaria 90 Nm
= Coppia per uso inclinato
94,5 Nm

ARTICOLO	CODICE	CAPACITÀ	☑	L (MM)	RISOL.
810 F 100	U08104013	20 ÷ 100	1/2"	447	0,25
810 F 200	U08104015	40 ÷ 200	1/2"	500	0,5

~~€ 203,00~~ € 132,00

~~€ 203,00~~ € 132,00

814 A

10÷200
Nm

Dispositivo digitale coppia-angolo

- Permette serraggi coppia ed angolo di precisione digitale anche con utensili tradizionali
- Per serraggi destrorsi e sinistrorsi
- Scala di lettura in Nm/ft.lb/in-lb/kg.cm/gradi
- Doppia indicazione: luminosa (LED) e sonora (buzzer) al raggiungimento del valore impostato
- 9 valori di coppia o angolo preimpostabili
- 50 misurazioni memorizzabili
- In custodia di ABS con certificato di taratura
- Alimentazione: 2 batterie AAA (incluse)



Serraggi controllati utilizzando cricchetti o chiavi a T



1/2"



CODICE	CAPACITÀ	☑	RISOL.
U08140003	6,8 - 135	1/2"	0,1
U08140004	10 - 200	1/2"	0,1
U08140005	17 - 340	1/2"	0,1

~~€ 224,00~~ € 157,00

~~€ 257,00~~ € 180,00

~~€ 312,00~~ € 218,00

824 A

Precisione
±6%

Giraviti dinamometrici

- Modello a coppia regolabile per serraggi destrorsi da utilizzare in abbinamento agli inserti della serie 660 o, tramite raccordo, alle chiavi a bussola della serie mano da 1/4"
- Scala di lettura in Nm
- Disinnesto automatico al raggiungimento della coppia impostata
- Riarmo automatico dopo 120°
- Fornito con chiave di regolazione e certificato di collaudo



1/4"

UNI-EN 26789

CODICE	CAPACITÀ	L (MM)	RISOL.
U08240004	0,5÷2,5	145	0,1
U08240006	2÷10	167	0,5

~~€ 215,00~~ € 151,00

~~€ 219,00~~ € 153,00

LAMPADE DI ISPEZIONE A LED

STANDARD



889 RD

EXTRA SOTTILE



889 SA

COMPATTA



889 RP



Fonte di luce

SMD LED

COB LED

COB LED (Lampada)
SMD LED (Torcia)



Flusso luminoso
(lumen)

200 (Lampada)
50 (Torcia)

500 (Boost)
250 (Normale)

180 (Lampada)
60 (Torcia)

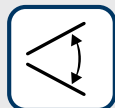

Angolo di
emissione
luminosa

60°

120°

110° (Lampada)
65° (Torcia)



Autonomia
(ore)

5 (Lampada)
9 (Torcia)

2,5 (Boost)
5 (Normale)

3 (Lampada)
10 (Torcia)



Tempo di
ricarica (ore)

4,5

4

4,5



Grado
di protezione

IP20

IP54

IP20



Resistenza
agli urti

IK07

IK06

IK07



Tipo batteria

3,7 V Li-Ion
2400 mAh

3,7 V Li-Poly
1750 mAh

3,7 V Li-Ion
1800 mAh



Temperatura di
utilizzo

- 20°
+60°

- 10°
+40°

- 20°
+50°



Fissaggio

2 ganci
2 magneti

1 gancio
2 magneti

1 gancio
1 magnete



Peso

260 g

125 g

140 g

EXTRA SOTTILE ALTA LUMINOSITÀ

Gancio
flessibile

Magnete



SOLO
12 mm

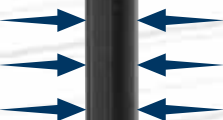

NEW

Magnete



2 LIVELLI DI LUMINOSITÀ



INDICATORE
DI CARICA



USB



COB
LED

IK06

4 h

2,5/5 h

IP54

Li-Poly

889 SA

Cod. U08890019

Lampada ispezione a LED
extra sottile ad alta luminosità

€ 112,00

€ 77,00

Accessori
inclusi



COLORATE NON LE PERDI PIÙ!



DOPPIA FUNZIONE



LAMPADA



TORCIA

RICARICABILE



889 RD

Cod. U08890035

Lampada di ispezione a LED

~~€ 94,50~~

€ 65,00



SMD LED



Lampada: 5 h
Torcia: 9 h



IK07



IP20



3 h



Li-ion

DOPPIA FUNZIONE



LAMPADA



TORCIA

RICARICABILE



889 RP

Cod. U08890045

Lampada a LED ricaricabile compatta

~~€ 57,00~~

€ 39,00



Lampada COB LED



Torcia SMD LED



Lampada: 3 h
Torcia: 10 h



IP20



4,5 h



Li-ion



180 mm

Tasto On/Off

Clip di aggancio in metallo

NEW



USB

Tempo di ricarica 2,5 h

RICARICABILE DOPPIA FUNZIONE



110
LUMEN

LAMPADA



70
LUMEN

TORCIA



Lampada COB LED



Torcia SMD LED



Lampada: 2,5 h
Torcia: 3 h



IP54



IK06



Li-Poly

889 TE

Cod. U08890018

Torcia a LED ricaricabile - doppia funzionalità

~~€ 71,50~~

€ 49,00

RESISTENTE ALL'ACQUA, POLVERE E CADUTE!



180°

130 mm

NEW



Base magnetica



3 LIVELLI DI LUMINOSITÀ



MAX
1500
LUMEN

500, 1000 e 1500 lumen con un semplice tocco



COB LED

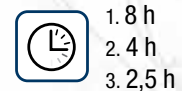

1.8 h
2.4 h
3.2,5 h



IP67



IK07



2,5 h



Li-Ion

889 RT

Cod. U08890038

Faretto a LED ricaricabile - certificato IP67

~~€ 245,00~~

€ 169,00

FUNZIONA CON O SENZA CAVO!
Cavo da 5 metri incluso





942 PC1 1/2''

Cod. U09420002

Avvitatore ad impulsi in titanio

- Modello reversibile con meccanismo a doppio martello
- Motore monoblocco
- 3 livelli di potenza per il serraggio, coppia al massimo in svitatura
- Corpo in resina ad alta resistenza con carter anteriore in titanio
- Impugnatura bimatereale soft-touch
- Paracolpi laterali in gomma
- Peso bilanciato per il massimo comfort

~~€ 419,00~~

€ 293,00

CARATTERISTICHE TECNICHE

Attacco quadro	1/2
Capacità bullone	M20
Coppia massima (Nm)	1.700
Coppia di lavoro (Nm)	200÷450
Velocità a vuoto (giri/min)	7.225
Pressione aria raccomandata (bar)	6,2

CARATTERISTICHE TECNICHE

Attacco aria	1/4
Diametro interno tubo aria (mm)	10
Consumo medio aria (l/min)	144 l/min
Pressione sonora (dB(A))	94,2
Potenza sonora (dB(A))	105,2
Vibrazioni (m/s ²) - (k)	4,91 - 0,97



928 PC1 1/2''

Cod. U09280060

Avvitatore ad impulsi in composito

- Modello reversibile con meccanismo a doppio martello
- Scarico dell'aria convogliato attraverso l'impugnatura
- Coppia di lavoro regolabile
- Carcassa ultraleggera in materiale composito ad alta resistenza e carter anteriore in acciaio

~~€ 308,00~~

€ 216,00

CARATTERISTICHE TECNICHE

Attacco quadro	1/2
Capacità bullone	M16
Coppia massima (Nm)	1.080
Coppia di lavoro (Nm)	100÷400
Velocità a vuoto (giri/min)	7.700
Pressione aria raccomandata (bar)	6,2

CARATTERISTICHE TECNICHE

Attacco aria	1/4
Diametro interno tubo aria (mm)	10
Consumo medio aria (l/min)	143
Pressione sonora (dB(A))	96
Potenza sonora (dB(A))	107
Vibrazioni (m/s ²) - (k)	10,2 - 1,45



928 C1 1/2''

Cod. U09280010

Avvitatore ad impulsi in alluminio

- Modello reversibile con meccanismo a doppio martello
- Scarico dell'aria convogliato attraverso l'impugnatura
- Coppia di lavoro regolabile

~~€ 259,00~~

€ 181,00

CARATTERISTICHE TECNICHE

Attacco quadro	1/2
Capacità bullone	M16
Coppia massima (Nm)	1.015
Coppia di lavoro (Nm)	150÷380
Velocità a vuoto (giri/min)	7.100
Pressione aria raccomandata (bar)	6,2

CARATTERISTICHE TECNICHE

Attacco aria	1/4
Diametro interno tubo aria (mm)	10
Consumo medio aria (l/min)	120
Pressione sonora (dB(A))	93
Potenza sonora (dB(A))	104
Vibrazioni (m/s ²) - (k)	8,40 - 1,33

942 PC3 1/2

Cod. U09420012

Avvitatore ad impulsi - extra compatto

- Struttura extra compatta: 11 cm di lunghezza
- Modello reversibile con sistema di percussione JUMBO
- Scarico dell'aria convogliato nell'impugnatura
- 3 livelli di potenza impostabili per il serraggio, coppia sempre al massimo in svitatura
- Corpo ed impugnatura in materiale antiscivolo
- Paracolpi laterali a protezione del carter motore

~~€ 212,00~~

€ 148,00

CARATTERISTICHE TECNICHE		CARATTERISTICHE TECNICHE	
Attacco quadro	1/2	Attacco aria	1/4
Capacità bullone	M16	Diametro interno tubo aria (mm)	10
Coppia massima (Nm)	861 Nm	Consumo medio aria (l/min)	127
Coppia di lavoro (Nm)	150÷220 Nm	Pressione sonora (dB(A))	91,1
Velocità a vuoto (giri/min)	10.000	Potenza sonora (dB(A))	108,1
Pressione aria raccomandata (bar)	6,2	Vibrazioni (m/s ²) - (k)	9,57 - 1,4

928 D1 3/4"

Cod. U09280015

Avvitatore ad impulsi in alluminio

- Modello reversibile
- Scarico dell'aria convogliato attraverso l'impugnatura

~~€ 800,00~~

€ 560,00

CARATTERISTICHE TECNICHE		CARATTERISTICHE TECNICHE	
Attacco quadro	3/4	Attacco aria	3/8
Capacità bullone	M24	Diametro interno tubo aria (mm)	13
Coppia massima (Nm)	2.400	Consumo medio aria (l/min)	193
Coppia di lavoro (Nm)	500÷1.050	Pressione sonora (dB(A))	98,4
Velocità a vuoto (giri/min)	5.700	Potenza sonora (dB(A))	109,4
Pressione aria raccomandata (bar)	6,2	Vibrazioni (m/s ²) - (k)	9,1 - 1,61

922 B1

Cod. U09220001

Smerigliatrice dritta

~~€ 133,00~~

€ 93,00

CARATTERISTICHE TECNICHE		CARATTERISTICHE TECNICHE	
Potenza (W-CV)	220-0,3	Diametro interno tubo aria (mm)	10
Capacità pinza	6	Consumo medio aria (l/min)	76
Velocità a vuoto (giri/min)	30.000	Pressione sonora (dB(A))	99,5
Pressione aria raccomandata (bar)	6,2	Potenza sonora (dB(A))	95,8
Attacco aria	1/4	Vibrazioni (m/s ²) - (k)	2,42 - 0,74



**EXTRA
COMPATTO**



SCARPE ANTINFORTUNISTICHE S1P

TOMAIA ALTAMENTE TRASPIRANTE

SOLETTA AMMORTIZZANTE

Confortevole, anatomica, antibatterica

NEW

Made in Italy

S1P
SRC

TOMAIA IN MESH CON MICROFIBRA

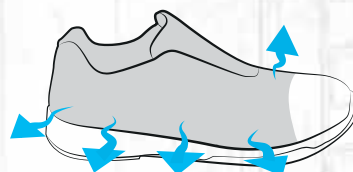

TRASPIRANTE

CALZATA

12

SUOLA IN POLIURETANO BIDENSITÀ

iniettata direttamente sulla tomaia per la massima qualità

PUNTALE IN COMPOSITO

**100%
METAL
FREE**

INTERSUOLA ANTIPERFORAZIONE

3500 S1P

Scarpe antinfortunistiche con tomaia traspirante

- Categoria S1P
- Calzatura bassa in Mesh con microfibra sovrastampata
- Fodera 100% poliestere con lavorazione a nido d'ape per migliorare il ricircolo dell'aria a vantaggio della traspirazione
- Puntaletto in composito leggero e resistente
- Soletta estraibile preformata, in poliuretano bicolore e bi-densità, traspirante, lavabile ed antibatterica. Offre ottime performance in termini di comfort e di ammortizzamento
- Suola in poliuretano bi-densità resistente alle flessioni ed alle abrasioni, antiolio, antiscivolo
- Intersuola confortevole antiperforazione
- Calzata 12
- 100% metal free
- Campi di impiego suggeriti: Lavori leggeri, industria meccanica, logistica/imballaggio



EN ISO 20345: 2011

TAGLIA	CODICE	TAGLIA	CODICE
36	U35000036	42	U35000042
37	U35000037	43	U35000043
38	U35000038	44	U35000044
39	U35000039	45	U35000045
40	U35000040	46	U35000046
41	U35000041	47	U35000047

~~€ 100,00~~

€ 70,00



3730 B

Cod. U37300010G

Cappellino

- Tessuto: poliestere jacquard
- Colore blu
- Taglia unica regolabile con cinturino e velcro con passante

~~€ 13,50~~

€ 10,00

3720 B

Polo manica corta uomo

- 100% cotone piquet pettinato

~~€ 20,90~~

€ 15,50

TAGLIA	CODICE
S	U37200013G
M	U37200014G
L	U37200015G
XL	U37200016G
XXL	U37200017G

3712 B

Felpa con cappuccio uomo

- 80% cotone pettinato - 20% poliestere
- Cappuccio doppiato con interno in jersey
- Zip in nylon invisibile
- 2 tasche a filetto

~~€ 77,00~~

€ 57,00

TAGLIA	CODICE
S	U37120014G
M	U37120015G
L	U37120016G
XL	U37120017G
XXL	U37120018G

3706 D

Jeans da lavoro

- Jeans multistagione 6 tasche
- Tessuto elasticizzato 96% cotone - 4% lycra
- Colore Blu scuro

~~€ 65,00~~

€ 48,00

TAGLIA	CODICE
S	U37060034G
M	U37060035G
L	U37060036G
XL	U37060037G
XXL	U37060038G



**2006/42/CE
EN1494+A1**

3t



2550 A
Cod. U25500001

3
TON

30,5
Kg

Sollevatore idraulico 3T per auto e veicoli commerciali

- Struttura in acciaio
- Polivalente e compatto
- Portata elevata per utilizzo su auto, fuoristrada e furgoni
- Sistema a doppia pompa per sollevare più velocemente la vettura
- Dotato di comando di discesa manuale
- Valvola di spurgo dell'aria, per evitare il pericolo di over-carico
- Impugnatura con gomma antiurto
- Ruote in poliuretano

~~€ 289,00~~

€ 199,00



COMPATTO

Solo 615 mm di lunghezza



133-465
mm



**2006/42/CE
EN1494+A1**

**Pedale di
avvicinamento**

2t



2550 B
Cod. U25500002

2
TON

32,5
Kg

Sollevatore idraulico 2T

- Struttura in acciaio
- Per utilizzo in spazi ridotti
- Sistema a doppia pompa per sollevare più velocemente la vettura
- Dotato di pedale di avvicinamento
- Dotato di comando di discesa manuale
- Valvola di spurgo dell'aria, per evitare il pericolo di over-carico
- Impugnatura con gomma antiurto
- Ruote in poliuretano

~~€ 407,00~~

€ 285,00



SOTTILE

Solo 75 mm di altezza



75-505
mm

1950 C



Coppia colonnette

- Altezza regolabile tramite meccanismo dentato con rilascio a leva
- Perno di bloccaggio con catena
- 1950 C/3: modello regolabile a 10 posizioni
- 1950 C/6: modello regolabile a 13 posizioni

CODICE	PORTATA	PESO
U19501001	3 t	7 Kg
U19501002	6 t	14 Kg

~~€ 80,00~~ **€ 56,00**
~~€ 116,00~~ **€ 81,00**

	A	B	C	C1	C2	D	E
3 t	207	188	242	300	427	27	88
6 t	285	250	342	400	620	28	100

Tutte le misure sono espresse in "mm"

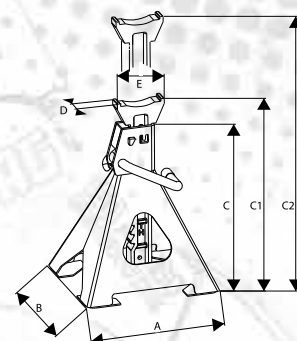

1951 B

Sollevatori a bottiglia

- Larga base di appoggio per un'estrema stabilità in tutte le posizioni di lavoro
- Dotati di vite di prolunga regolabile con fermo di sicurezza
- Valvola di fine corsa automatica
- Tutti i modelli vengono forniti con l'apposito manico di comando



CODICE	PORTATA	PESO
U19512000	2 t	2 Kg
U19512001	5 t	3,5 Kg
U19512002	12 t	6 Kg

~~€ 35,10~~ **€ 24,50**
~~€ 42,20~~ **€ 29,50**
~~€ 80,00~~ **€ 56,00**

	A	B	C	D	E	FXG
2 t	173	122	60	355	23	90x90
5 t	200	144	79	423	34	110x110
12 t	220	157	70	447	43	125x125

Tutte le misure sono espresse in "mm"

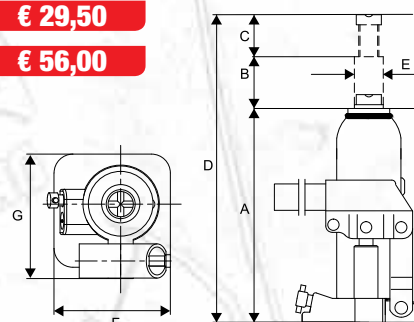

2000 A

Cod. U20000100

Lettino sottoscocca 6 ruote

- Cuscino poggiatesta in vinile resistente agli idrocarburi.
- Struttura in materiale plastico resistente agli idrocarburi, lavabile
- Due vaschette porta utensili laterali
- Altezza massima da terra: 115mm
- Fornito con 6 ruote in gomma pivottanti Ø 80mm (da montare)

~~€ 104,00~~

€ 70,00

KG
150

CAPACITÀ
Ø 66÷105 mm



EFFETTO CRICCHETTO

- Rapidità e facilità d'uso anche in spazi ridotti

SERRAGGIO AUTOMATICO DEL NASTRO

- Velocizzazione dell'operazione
- Ottimizzazione dell'effetto cricchetto

443 N

Cod. U04430005

Chiave automatica a ripresa rapida per filtri olio (autovetture)

- Regolazione automatica del nastro
- Leva di incremento potenza di serraggio per un grip perfetto sul filtro
- Ganasce snodate per il trattenimento del filtro e l'effetto cricchetto
- Nastro in acciaio inox
- Impugnatura (160 mm) in materiale plastico ad alta resistenza (idrocarburi, urti)

~~€ 88,50~~

€ 62,00



3/8"
1/2"

446 S28

Cod. U04461204

Assortimento di 30 chiavi per filtri olio

- Serie composta da 28 chiavi a tazza con quadro di manovra da 3/8", 1 adattatore da 3/8" a 1/2", 1 chiave autoserrante (capacità 65÷120 mm) con quadro di manovra da 3/8"
- Il set è adatto per la maggior parte dei filtri olio montati sui veicoli circolanti
- Misure delle 28 chiavi a tazza Ø x N°lati:
66/6 - 65/14 - 65/67 - 68/14 - 73/14 - 74/15 - 74/76 - 75/77 - 76/12 - 76/14 - 76/30 - 76/8 - 78/15 - 80/15 - 80/82 - 86/16 - 86/18 - 90/15 - 92/10 - 93/15 - 93/36 - 93/45 - 95/15 - 96/18 - 100/15 - 106/15 - 108/15 - 108/18

~~€ 171,00~~

€ 120,00

7 Kg
L. 620
H. 80
P. 490



468 M

Utensile a percussione per anelli di tenuta e guarnizioni

- Semplifica l'inserimento di anelli di supporto esterni per cuscinetti obliqui
- Asse, sede dei cuscinetti e anelli di tenuta non vengono danneggiati
- Ghiera regolabile in 3 posizioni
- Impugnatura in acciaio

CODICE	CAPACITÀ (MM)	LUNGHEZZA	€ 87,00	€ 60,00
U04680150	9,5÷50	130	€ 109,00	€ 75,00
U04680151	18÷90	145		

468 M1

3 REGOLAZIONI



Ø 9,5÷23,5 mm



Ø 23,5÷36,5 mm



Ø 36,5÷50 mm

468 M2

3 REGOLAZIONI



Ø 18÷53 mm



Ø 41÷76 mm



Ø 54÷90 mm

Just **USAG**

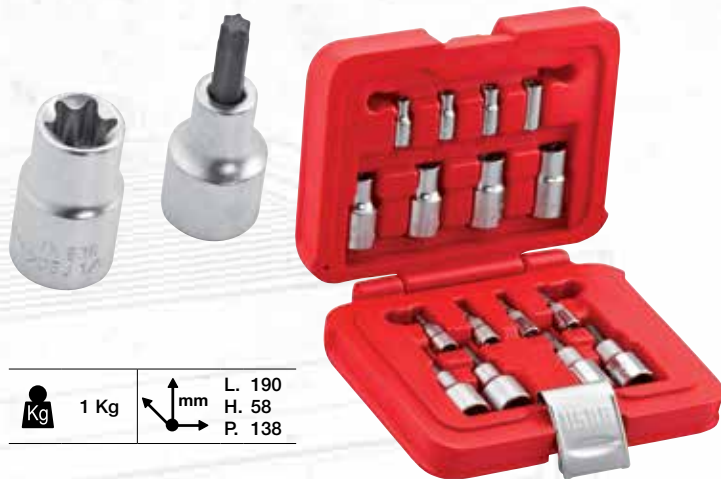

601 1/4-1/2 JTX16

Cod. U06010009



16
PEZZI

Assortimento in cassetta modulare con bussole TORX®

~~€ 36,60~~

€ 25,50

DESCRIZIONE	MISURA	PZ.
Chiavi a bussola 1/4 TORX®	E6-E7-E8-E10	4
Chiavi a bussola 1/2 TORX®	E12-E14-E16-E18	4
Chiavi a bussola 1/4 con inserto TORX®	T10-T15-T20-T25	4
Chiavi a bussola 1/2 con inserto TORX®	T30-T40-T45-T50	4

870 C

Cod. U08700006

Pinza per raccordi rapidi carburante

- Per veicoli a benzina e diesel
- Impugnature ergonomiche bimalteriali
- Lunghezza: 175 mm

~~€ 55,50~~

€ 39,00



3 POSIZIONI
DI LAVORO



871 C

Cod. U08719005P

Pinza per fascette automatiche CLIC

- Testa triassiale per lavorare in tutte le posizioni
- Permette di aprire o chiudere le fascette automatiche presenti sui circuiti del carburante, dei collettori d'aspirazione e dei circuiti idraulici

~~€ 65,50~~

€ 46,00



Anche per sistema start & Stop

890 K

Cod. U08901000

Tester digitale per batterie con stampante

- Misura lo stato di carica, la capacità e l'efficienza della batterie da 6 a 12V, anche con sistema "Start & Stop"
- Verifica l'efficienza dell'alternatore e impianto di avviamento da 12 a 24V
- Permette di testare batterie: EFB, AGM piatta, AGM SPIRALE, VRLA/GEL, Liquido standard
- Schermo LCD
- 6 lingue selezionabili
- Lunghezza cavi: 2 m
- Fornito in valigetta di plastica, con guscio antiurto e 2 rotoli di carta

~~€ 580,00~~

€ 406,00

CARATTERISTICHE TECNICHE

Analisi batterie	6-12 V
Sistema di ricarica	12-24 V
Capacità batteria Start & Stop	SAE (CCA): 40÷2000 A, EN: 40÷2100 A, DIN: 25÷1300 A, IEC: 30÷1500 A
Capacità batteria standard	SAE (CCA): 40÷3000 A, EN: 40÷2830 A, DIN: 25÷1685 A, IEC: 30÷1985 A
Display	LCD
Tipo batteria (fornite)	4xAA

NEW



1270÷2100 mm



**500
LUMEN**

889 UB

Cod. U08890034

Lampada LED sottocofano ricaricabile

~~€ 172,00~~

€ 120,00



SMD
LED



3 h



IK07



IP44



4 h



Li-ion



280÷540 mm



Ø 500÷900 mm

1955 A

Cod. U19550001

600
KG

Carrello per movimentazione veicoli

- Permette di facilitare lo spostamento di veicoli danneggiati o bloccati
- L'utilizzo di quattro carrelli consente un posizionamento e manovra a piacere della vettura
- Comando del cilindro idraulico tramite pedale
- Rulli scorrevoli in alluminio
- 4 ruote pivotanti bimalteriali

~~€ 264,00~~

€ 185,00





263 RA

Cod. U02631600

CAPACITA'
80 L

Recuperatore olio

- Modello a caduta
- Indicatore laterale per la verifica del livello olio nel serbatoio
- Griglia in materiale plastico all'interno della coppa
- Sistema di svuotamento del serbatoio con aria compressa (max 3,5 bar)
- Tubo di scarico flessibile lungo 1800 mm
- 4 ruote pivotanti: \varnothing 70 mm

~~€ 516,00~~

€ 285,00

Kg	35 Kg	mm	L. 550
			H. 1580
			P. 550

Compatibile con liquido freni DOT ed antigelo



Tubo esterno antiurto in poliuretano per il controllo del serbatoio



Blocco di giunzione in metallo con guarnizione interna in EPDM



263/S16

Cod. U02631400

16
PEZZI

Kit per tappi olio (16 pz)

- 1 chiave snodata con coppetta
- 2 inserti \varnothing 8-10 mm
- 6 inserti \varnothing 8-10-12-13-14-17 mm
- 6 bussole \bullet 13-14-17-18-19-21 mm
- 1 inserto \varnothing T45



~~€ 159,00~~

€ 111,00

3/8"

3/8"



263 VAG

Cod. U02631150



Bussola per tappi olio Audi e Volkswagen

- Quadro di manovra: 3/8"
- Per lo svitamento e la rimozione dei nuovi tappi olio in plastica montati su tutte le nuove vetture Audi e Volkswagen
- Utilizzabile sui seguenti modelli di auto:
 - Audi A1, A3, A4, A5, A6, A7, Q3, Q5, Q7, TT, TTS
 - Seat Alhambra, Leon, Toledo
 - Skoda Octavia, Rapid, Superb, Yeti
 - Volkswagen Maggiolino, Caddy, CC, Golf, Jetta, Passat, Polo, Scirocco, Sharan, Tiguan, Touran

~~€ 15,00~~

€ 10,50



1308 K1
Cod. U13080085

~~€ 333,00~~

€ 229,00



1308 K2
Cod. U13080086

~~€ 325,00~~

€ 223,00



1308 K3
Cod. U13080087

~~€ 546,00~~

€ 375,00



1309 K1
Cod. U13090085

~~€ 338,00~~

€ 232,00



1309 K2
Cod. U13090086

~~€ 591,00~~

€ 407,00



1311 K1
Cod. U13110085

~~€ 333,00~~

€ 229,00



1311 K2
Cod. U13110086

~~€ 209,00~~

€ 144,00



1312 K1
Cod. U13120085

~~€ 371,00~~

€ 255,00



1312 K2
Cod. U13120086

~~€ 338,00~~

€ 232,00



1313 K1
Cod. U13130085

~~€ 363,00~~

€ 250,00



1313 K2
Cod. U13130086

~~€ 325,00~~

€ 223,00



1313 K3
Cod. U13130087

~~€ 317,00~~

€ 218,00



Diesel



Benzina



1315 K1
Cod. U13150085



~~€ 325,00~~

€ 223,00



1315 K2
Cod. U13150086



~~€ 385,00~~

€ 265,00



1315 K3
Cod. U13150087



~~€ 338,00~~

€ 232,00



1315 K4
Cod. U13150088



~~€ 89,50~~

€ 62,00



1315 K5
Cod. U13150089



~~€ 361,00~~

€ 249,00



1344 K1
Cod. U13440085



~~€ 164,00~~

€ 113,00



Jeep

1344 K2
Cod. U13440086



~~€ 149,00~~

€ 102,00



1344 K3
Cod. U13440087



~~€ 296,00~~

€ 204,00



1344 K4
Cod. U13440088



~~€ 275,00~~

€ 189,00



1344 K5
Cod. U13440089



~~€ 225,00~~

€ 150,00



1344 K6
Cod. U13440090



~~€ 225,00~~

€ 150,00



Vuoi maggiori informazioni?

Inquadra il QR Code
o vai su usag.it/download/
per scaricare la guida alla messa in fase
con il dettaglio dei codici motore
e modelli di auto



447 T

Cod. U04470101

Smonta ammortizzatori pneumatico

- Ideale per autovetture
- Sistema di autolivellamento dei bracci superiori: adatto anche a molle coniche e disassate
- Boccole autolubrificanti: nessuna operazione di lubrificazione e/o ingrassaggio sulle colonne di scorrimento
- Fornito con due staffe inferiori 447 TC1 (78÷130 mm) e 447 TC2 (125÷205 mm), morsa 447 TA e morsetti superiori universali 447 TB1

~~€ 1.657,00~~

€ 1.150,00

Kg	60 Kg	mm	L. 470
			H. 1390
			P. 450

POTENZA DI COMPRESSIONE

735 KG (6 BAR)

1226 KG (10 BAR)

CARATTERISTICHE TECNICHE

Potenza compressione	735 Kg (6 bar) - 1226 Kg (10 bar)
Pressione di esercizio	6÷10 bar
Corsa del pistone	420 mm
Cilindro	Doppio in lega d'alluminio e resina al nylon



CONFORMITA' ALLA DIRETTIVA MACCHINE

Gli smontammortizzatori pneumatici USAG sono progettati per rispondere pienamente alla Direttiva Macchine 2006/42/CE. Alcune funzionalità della macchina sono state impostate perché l'operatore possa lavorare in totale sicurezza:

- Protezione frontale di sicurezza
- Dispositivo di arresto del pistone in caso di apertura della protezione frontale
- Velocità limitata: sempre inferiore ai 10 cm/sec
- Sistema di blocco delle ganasce e del pistone in caso di interruzione dell'alimentazione dell'aria



448 M

Cod. U04480010

Leva per smontaggio montanti sospensioni/braccetti

- Per lo smontaggio in modo rapido e sicuro di: montanti delle sospensioni MAC PHAERSON snodi sferici dei braccetti
- Gancio regolabile in 5 posizioni: precisione e facilità di utilizzo
- Lunghezza 120 cm

~~€ 250,00~~

€ 175,00



2800 S21
Cod. U28000085

21
PEZZI

Kit di 21 utensili per pistoncini freni

- Assortimento per comprimere e ruotare i pistoncini dei freni a disco anteriori e posteriori
- Permette di riposizionare agevolmente i pistoncini del freno nell'alloggiamento della pinza
- Include 2 mandrini con rotazione destra e sinistra e da diverse piastre, adattatori e accessori
- Compatibile con i seguenti modelli d'auto: CITROEN, AUDI, FIAT/ALFA ROMEO, FORD, ISUZU, HONDA, JAGUAR, BMW, MERCEDES, MITSUBISHI, NISSAN, ROVER, TOYOTA, VOLVO, VOLKSWAGEN, MAZDA, SAAB, GM, SUBARU, PEUGEOT, RENAULT, MINI, OPEL
- Fornito in cassetta di plastica

~~€ 150,00~~

€ 105,00

SPURGATORE PER CIRCUITO FRENI

Pressione regolabile fino a 4 bar

NEW



2847/3

Cod. U28470084

Spurgatore per circuito freni

- Permette di cambiare, riempire, spurgare i circuiti dei freni di autovetture e veicoli industriali
- Apparecchio progettato esclusivamente per liquidi freno tipo DOT 3, DOT 4, DOT 5.1. No LHM
- Pressione regolabile fino a 4 bar
- Arresto automatico al 10% del serbatoio (1 L)
- Alimentazione 12 V tramite cavi batteria
- Vano posteriore accessori
- Ruote integrate e maniglione per un facile trasporto

~~€ 1.308,00~~

€ 916,00

CARATTERISTICHE TECNICHE

Sistema di manovra del liquido	Pompa peristaltica (nessun contatto diretto pompa liquido, nessuna pressione aria sul liquido)
Alimentazione	12 V (morsetti batteria)
Capacità serbatoio	10 litri
Limitatore di pressione	4 bar
Tubo a spirale	4 m (elastico)
Cavo di alimentazione	4 m



3500 A



BATTERIE AGM
(Absorbed Glass Mat)



1613 AB12

Cod. U16130009

12 V **1200 A**

Avviatore portatile 12V

- Per avviamento di soccorso, come caricabatterie e come fonte di energia supplementare per veicoli (salvamemorie) e per apparecchi elettrici 12V
- Scocca antiurto in ABS
- Protezione da sovratensione
- Idoneo anche per batterie sigillate
- Pinze inclinate
- Fornito con caricatore di rete e cavo per presa accendisigari

~~€ 478,00~~

€ 335,00

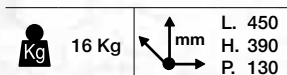

LUNGHEZZA CAVI 155 CM

1613 OBD

Cod. U16130003

Cavo OBD salva-memorie 12 V

- Funziona collegato ad un avviatore 12V tramite attacco accendisigari
- Si collega al veicolo con connettore OBD (ingresso diagnosi)
- Compatibile con tutte le connessioni E-OBD e OBD-II
- Collegandolo all'interno dell'abitacolo permette di lavorare comodamente con il veicolo sul ponte sollevatore
- Fusibile di protezione integrato
- Lunghezza cavo: 2 metri

~~€ 45,70~~

€ 32,00

1881 S22

Cod. U18810082

22 PEZZI

Kit universale per lo smontaggio e il montaggio delle ghiera pulegge alternatori

- Fornito in cassetta di plastica

~~€ 117,00~~

€ 82,00



NUOVO AVVIATORE PORTATILE 12-24 V



NEW

PORTA USB DA 2,1A

per per la carica di dispositivi elettronici (tablet, smartphone, MP3, notebook, macchine fotografiche, ecc)



12 V
4600 A

24 V
2300 A

LUNGHEZZA CAVI 146 cm

1613 AB12-24

Cod. U16130011

12 V
24 V

Avviatore portatile 12-24V

- Avviatore portatile d'emergenza per la messa in moto di veicoli con batterie funzionanti ma scariche, con possibilità di erogare tensioni a scelta da 12 o 24V
- Indicato per l'utilizzo su ogni tipo di mezzo: auto, mezzi commerciali, camion, macchine movimento terra, trattori agricoli, imbarcazioni, ecc.
- Voltmetro digitale con doppia funzionalità: indicazione dello stato di carica della batteria interna (in volts e in %) e indicazione del voltaggio della batteria del veicolo
- Scocca antiurto in ABS
- Protezione da sovratensione
- Idoneo per batterie sigillate
- Pinze inclinate
- Fornito con cavo di rete e cavo per presa accendisigari

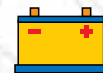

BATTERIE AGM
(Absorbed Glass Mat)

CARATTERISTICHE TECNICHE	
Tensione di utilizzo	12-24 V
Amperaggio di spunto 12V	4600 A
Amperaggio di spunto 24V	2300 A
Amperaggio continuo 12 V	1800 A
Amperaggio continuo 24 V	900 A
Tensione di ricarica	220-240 V AC
Lunghezza cavi	146 cm
Diametro cavi	33 mm ²
Tipo batteria	2XAGM 12 V-900 CA - 22, 40 Ah

~~€ 999,00~~

€ 699,00

SISTEMA MODULARE PER PROGETTO E MONTAGGIO

NEW



76
Kg

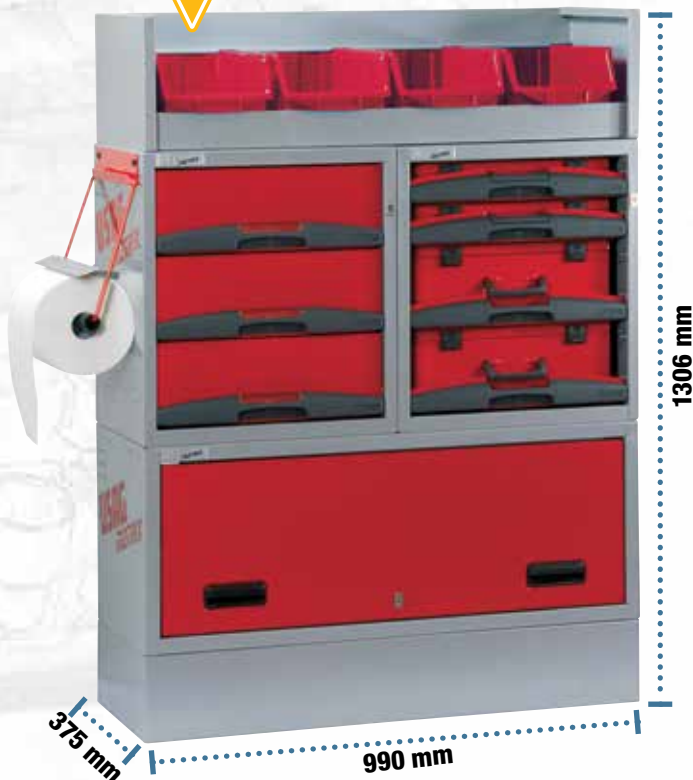

LATO DESTRO
o SINISTRO

5006 EF1

Cod. U50060034

~~€ 1.541,00~~

€ 1.130,00

Composizione:

DESCRIZIONE	CODICE	PZ.
Cassettera 5000 B4	U50000023	1
Cassettera 5000 D3	U50000062	1
Base passaruota 5002 B2N	U50020009	1
Porta-rotolo 5002 SA4	U50020066	1
Coppia montanti 5003 ME1	U50030049	1
Porta-vaschette 5003 A3/4	U50030078	1
Sistema di fissaggio	U50020048	1



Inquadra il QR code per verificare i modelli di furgoni compatibili

NEW



375 mm

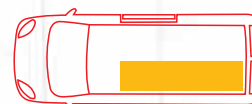

LATO SINISTRO

5006 EF2

Cod. U50060035

~~€ 1.548,00~~

€ 1.130,00

Composizione:

DESCRIZIONE	CODICE	PZ.
Cassettera 5000 E5	U50000105	1
Cassettera 5000 CE3	U50000052	1
Base passaruota 5002 B3	U50020010	1
Porta-flaconi 5002 SA5	U50020067	1
Coppia montanti 5003 MF1	U50030052	1
Ripiano porta vaschette 5003 A2/7	U50030074	1
Sistema di fissaggio	U50020048	2



Inquadra il QR code per verificare i modelli di furgoni compatibili

96

Kg

ALLESTIMENTO FURGONI. LI PUOI FARE TU.

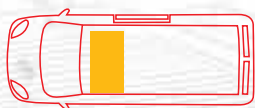

**RETRO
SCHIENA**

5006 EF3

Cod. U50060036

~~€ 639,00~~

€ 470,00

Composizione:

DESCRIZIONE	CODICE	PZ.
Ripiano 5003 RB1	U50030026	4
Ripiano 5003 RC1	U50030031	1
Coppia montanti 5003 MD1	U50030046	1
Coppia montanti 5003 MD3	U50030048	1
Coppia montanti 5003 ME1	U50030049	1
Sistema di fissaggio	U50020048	1

Esempio di composizione
con scaffalatura a pavimento

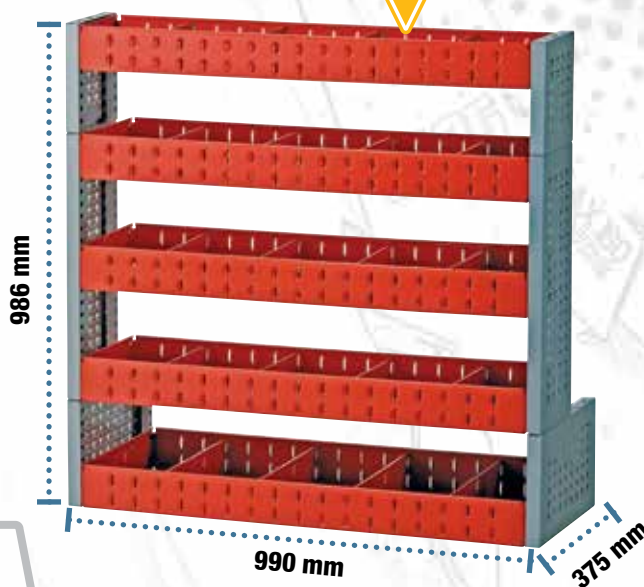

Inquadra il QR code per verificare
i modelli di furgoni compatibili

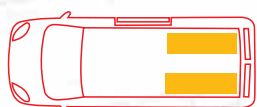

**LATO DESTRO
o SINISTRO**

5006 EF4

Cod. U50060037

~~€ 823,00~~

€ 605,00

Composizione:

DESCRIZIONE	CODICE	PZ.
Base passaruota 5002 A2N	U50020004	1
Ripiano 5003 RA1	U50030024	1
Ripiano inclinato 5003 RIB2	U50030037	1
Ripiano inclinato 5003 RIC2	U50030042	2
Coppia montanti 5003 MD2	U50030047	1
Coppia montanti 5003 ME2	U50030050	1
Sistema di fissaggio	U50020048	1

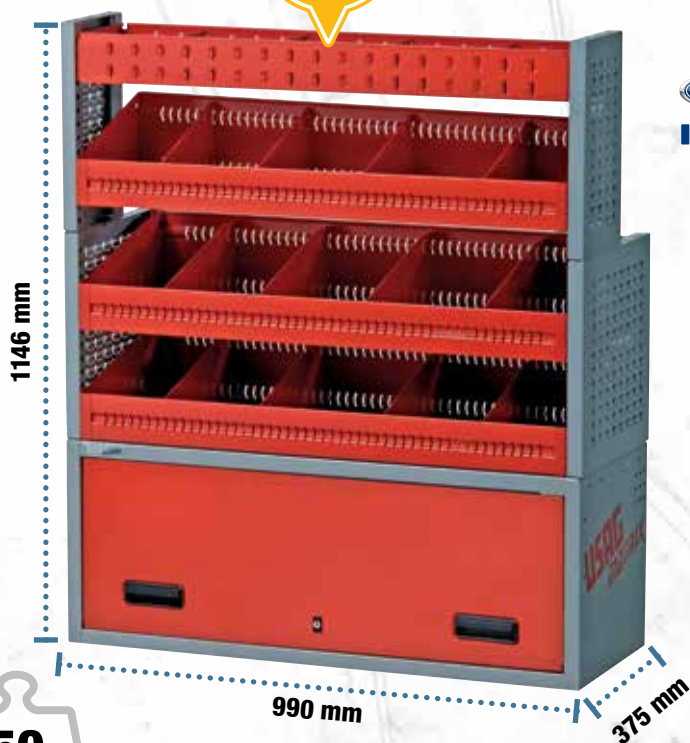

Inquadra il QR code per verificare
i modelli di furgoni compatibili



IL MONDO **MATRIX** SU YOUTUBE



Cos'è Matrix?

Tutto quello che c'è da sapere sulla
MODULARITÀ e VERSATILITÀ



Tutorial configuratore

Un breve video per scoprire
tutti i segreti del configuratore



Tutorial montaggio

Come allestire il tuo furgone passo passo.



**1. Preparazione
all'allestimento**

**2. Ancoraggio
barre al veicolo**

**3. Montaggio
moduli**

Offerta valida fino al 31 Agosto 2018 salvo esaurimento scorte, presso i Rivenditori che aderiscono all'iniziativa.

Tutti i prezzi sono da intendersi in Euro, IVA esclusa. Le immagini riprodotte in questa brochure sono indicative.
Stanley Black & Decker Italia S.r.l. si riserva in ogni momento di modificare le caratteristiche tecniche dei prodotti.